



# PRODUCT CATALOG

Vol. 13.0

*Experience the Clover difference.*



**CLOVER MFG. CO.,LTD.**

Clover manufactures products that are safe and reliable from the customers' perspective, and which are also environmentally friendly.



### Clover's quality policy

- We maximize our corporate value by manufacturing products that satisfy and resonate with customers.
- We reflect customers' demands and expectations into product manufacturing.
- We actively respond to environmental issues under our motto of being a company that is friendly to people and the environment.



#### Our symbol of commitment to quality

- Origin of our Clover Mark -

When Toshio Okada, the founder of Clover Mfg. Co., Ltd., started to work for a needle wholesaler in Osaka at the age of 14, his mentor gave him a textbook on moral philosophy. As a bookmark for this book, Toshio used a clover leaf grown in his hometown. In 1925, he opened his own shop, and soon after World War II, began manufacturing products on a full scale to provide consumers with needles and sewing tools. That was when he decided to use the design of the clover leaf—sandwiched between the pages of a book he had when he left home—as a mark to assure product quality. Although needles are small items, they are essential to people's daily life, just like water and salt. The Clover Mark continues to represent the founder's philosophy of assuring quality and taking responsibility for even the smallest products the company offers.

#### Clover's environmental initiatives Obtained ISO 14001 certification



ISO 14001 certified  
Clover Mfg. Co., Ltd.  
Higashiosaka Office

Clover's Higashiosaka Office (including Osaka Factory and Central Distribution Center) acquired the international ISO 14001 environmental standard in 2000. The office acquired the certification again in June 2008 following its relocation and completion of the renewal procedure.

# Contents



Bamboo Knitting Needles <b>Takumi</b> <sup>®</sup>	4
Crochet Hooks	12
Knitting Accessories	17
Black Gold Needles	27
Sewing, Quilting & Embroidery Needles	29
Pins	32
Thimbles	35
Sewing Notions	37
Marking Tools	39
Silk Threads	44
Sewing & Patchwork Accessories	45
I Sew for Fun	60
Wonder Clips	62
Slash Cutter	65
Scissors	66
Rotary Cutters	68
Tape Makers	70
Fabric Tube Maker	72
Mini Iron & Accessories	73
Trace 'n Create	74
Bag & Totes Accessories	74
Embroidery Stitching Tools	75
<i>"Kantan Couture"</i> Bead Embroidery Tools	76
Swift Bead	77
Stitch Dome	77
"QUICK" Yo-Yo Makers	78
Kanzashi Flower Makers	79
Flower Frill Templates	79
Wonder Knitter	80
French Knitter	80
Flower Loom	81
Bracelet Maker	81
Pom-Pom Makers	82
Tassel Makers	83
Hair Pin Lace Tool	84
Needle Felting Tools	84
Natural Wool Rovings	85
Tatting Shuttles	86
Macrame Plant Hanger Guage	86
Mini Weaving Looms	87
Beading Loom	88
Rosette Makers	90
Clover Circles	91

# Bamboo Knitting Needles Takumi®

The art born from combining the finest raw materials and Clover's unmatched manufacturing technology.

*Each and every one of these high quality bamboo knitting needles has been created utilizing the properties of the finest natural materials.*

Takumi Bamboo Knitting Needles have been created with Clover's long-nurtured manufacturing technology which maximizes the qualities of the finest natural bamboo to achieve even a smoother, heartfelt knitting experience. Their smooth surface and comfortable fitting are the result of Clover's consideration for knitters. You will still be able to find these needles comfortable even after long hours of knitting.

Feel and experience these knitting needles made of carefully selected natural bamboo.

*Takumi's supreme quality also comes from Clover's excellent manufacturing technology*

- Excellent durability**  
 Only the finest parts of natural bamboo are used for knitting needles that perform year after year
- Clover's original, ideally shaped needle tip.**  
 Takumi Needles are comfortable to hold and will keep your yarn from splitting.
- Uniform shaft**  
 These needles feature a special finish that make shafts even—promising neat stitches and finishing.
- Smooth surface finish**  
 The surface is carefully finished to fit your hand comfortably and to make sure that yarn glides smoothly along the needles.

## Bamboo that becomes Takumi®

### Finest Top Quality Material

Bamboo is a strong, elastic and hardy fiber. Its smooth surface and comfortable fit are the most desirable for knitting needles. Only the most premium parts of the bamboo are used for the needles.

Place of origin is limited to cold areas with little snow. Bamboo in cold areas with little snow is very resistant to bending making this bamboo most desirable for knitting needles. Heavy snow conditions result in bent bamboo.

Appropriately aged Bamboo is selected. Young bamboo less than 3 years old is too soft while bamboo older than 5 years is too fragile. 4 to 5 year old bamboo is the most durable bamboo to use.

Cutting period is limited to winter. Bamboo in winter has less moisture and the fiber is more compact.

- We do not use bamboo nodes (joints) or the pieces, adjacent to nodes because those woody fibers are not straight enough.
- We use only those bamboo sections between nodes (internodes) that have adequate density.
- We cut and discard the bent portions, shoots and roots of bamboo trees.
- In order to make sure that materials do not shrink when they are dried, we use only the portion near the outer surface, where wood fiber texture is firm and tight.

Needle size (mm) Actual size

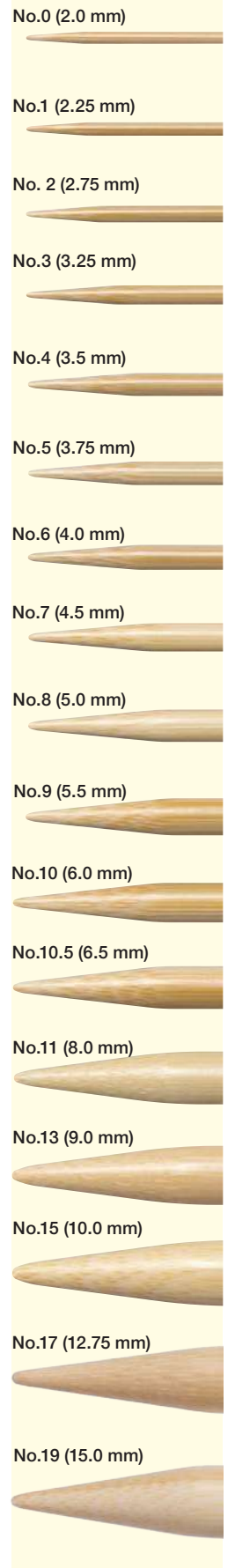



# Bamboo Knitting Needles Takumi®

## Bamboo Knitting Needles "Takumi"® Single Pointed

- The newly designed precision tips on Takumi single pointed knitting needles accommodate the finest yarns and virtually any knitting technique.



<b>3011/0-19</b>	
<b>Bamboo Knitting Needles "Takumi"® Single Pointed 9 in (23 cm)</b>	
Description	2 pc./pack 3 packs/box
Package Size	
Size 0-10.5	11.37 x 1.37 x 0.75 in
Size 11-19	11.37 x 2 x 0.75 in



<b>3012/0-19</b>	
<b>Bamboo Knitting Needles "Takumi"® Single Pointed 13 in/14 in (33 cm/36 cm)</b>	
Description	2 pc./pack 3 packs/box
Package Size	
Size 0-10.5	15.37 x 1.37 x 0.37 in
Size 11-15	16.25 x 2 x 0.75 in

<b>3011/8</b>	<b>No. 8 (5.0 mm)</b>

<b>3011/0</b>	<b>No. 0 (2.0 mm)</b>

<b>3011/9</b>	<b>No. 9 (5.5 mm)</b>

<b>3012/7</b>	<b>No. 7 (4.5 mm)</b>

<b>3011/1</b>	<b>No. 1 (2.25 mm)</b>

<b>3011/10</b>	<b>No. 10 (6.0 mm)</b>

<b>3012/0</b>	<b>No. 0 (2.0 mm)</b>

<b>3012/8</b>	<b>No. 8 (5.0 mm)</b>

<b>3011/2</b>	<b>No. 2 (2.75 mm)</b>

<b>3011/10.5</b>	<b>No. 10.5 (6.5 mm)</b>

<b>3012/1</b>	<b>No. 1 (2.25 mm)</b>

<b>3012/9</b>	<b>No. 9 (5.5 mm)</b>

<b>3011/3</b>	<b>No. 3 (3.25 mm)</b>

<b>3011/11</b>	<b>No. 11 (8.0 mm)</b>

<b>3012/2</b>	<b>No. 2 (2.75 mm)</b>

<b>3012/10</b>	<b>No. 10 (6.0 mm)</b>

<b>3011/4</b>	<b>No. 4 (3.5 mm)</b>

<b>3011/13</b>	<b>No. 13 (9.0 mm)</b>

<b>3012/3</b>	<b>No. 3 (3.25 mm)</b>

<b>3012/10.5</b>	<b>No. 10.5 (6.5 mm)</b>

<b>3011/5</b>	<b>No. 5 (3.75 mm)</b>

<b>3011/15</b>	<b>No. 15 (10.0 mm)</b>

<b>3012/4</b>	<b>No. 4 (3.5 mm)</b>

<b>3012/11</b>	<b>No. 11 (8.0 mm)</b>

<b>3011/6</b>	<b>No. 6 (4.0 mm)</b>

<b>3011/17</b>	<b>No. 17 (12.75 mm)</b>

<b>3012/5</b>	<b>No. 5 (3.75 mm)</b>

<b>3012/13</b>	<b>No. 13 (9.0 mm)</b>

<b>3011/7</b>	<b>No. 7 (4.5 mm)</b>

<b>3011/19</b>	<b>No. 19 (15.0 mm)</b>

<b>3012/6</b>	<b>No. 6 (4.0 mm)</b>

<b>3012/15</b>	<b>No. 15 (10.0 mm)</b>



# Bamboo Knitting Needles Takumi®

## Bamboo Knitting Needles "Takumi®" Double Pointed



3014/0-10.5	
<b>Bamboo Knitting Needles "Takumi®" Double Pointed 5 in (12.5 cm)</b>	
Description	5 pcs./pack 3 packs/box
Package Size	
Size 0-7	7.12 x 1.37 x 0.12-0.25 in
Size 8-10.5	7.12 x 1.75 x 0.25 in



3015/10-15	
<b>Bamboo Knitting Needles "Takumi®" Double Pointed 7 in (18cm)</b>	
Description	5 pcs./pack 3 packs/box
Package Size	
Size 0-7	9 x 1.37 x 0.12-0.25 in
Size 8-15	9 x 1.75 x 0.25 in

3015/7	No. 7 (4.5 mm)
0 5 1221 22207 8	

3014/0	No. 0 (2.0 mm)
0 5 1221 22120 0	

3014/6	No. 6 (4.0 mm)
0 5 1221 22126 2	

3015/0	No. 0 (2.0 mm)
0 5 1221 22200 9	

3015/8	No. 8 (5.0 mm)
0 5 1221 22208 5	

3014/1	No.1 (2.25 mm)
0 5 1221 22121 7	

3014/7	No. 7 (4.5 mm)
0 5 1221 22127 9	

3015/1	No. 1 (2.25 mm)
0 5 1221 22201 6	

3015/9	No.9 (5.5 mm)
0 5 1221 22209 2	

3014/2	No. 2 (2.75 mm)
0 5 1221 22122 4	

3014/8	No. 8 (5.0 mm)
0 5 1221 22128 6	

3015/2	No. 2 (2.75 mm)
0 5 1221 22202 3	

3015/10	No. 10 (6.0 mm)
0 5 1221 22210 8	

3014/3	No. 3 (3.25 mm)
0 5 1221 22123 1	

3014/9	No. 9 (5.5 mm)
0 5 1221 22129 3	

3015/3	No. 3 (3.25 mm)
0 5 1221 22203 0	

3015/10.5	No. 10.5 (6.5 mm)
0 5 1221 22211 5	

3014/4	No. 4 (3.5 mm)
0 5 1221 22124 8	

3014/10	No. 10 (6.0 mm)
0 5 1221 22130 9	

3015/4	No. 4 (3.5 mm)
0 5 1221 22204 7	

3015/11	No. 11 (8.0 mm)
0 5 1221 22212 2	

3014/5	No. 5 (3.75 mm)
0 5 1221 22125 5	

3014/10.5	No. 10.5 (6.5 mm)
0 5 1221 22131 6	

3015/5	No. 5 (3.75 mm)
0 5 1221 22205 4	

3015/13	No. 13 (9.0 mm)
0 5 1221 22213 9	

3015/6	No. 6 (4.0 mm)
0 5 1221 22206 1	

3015/15	No 15 (10.0 mm)
0 5 1221 22214 6	

# Bamboo Knitting Needles Takumi®

## Bamboo Circular Knitting Needles "Takumi"®



<b>3016/9-0~8</b>	
<b>Bamboo Circular Knitting Needles "Takumi"® 9 in (23 cm)</b>	
Description	1 pc./pack 3 packs/box
Package Size	7.12 x 2.37 x 0.25-0.5



<b>3016/16-0~15</b>	
<b>Bamboo Circular Knitting Needles "Takumi"® 16 in (41 cm)</b>	
Description	1 pc./pack 3 packs/box
Package Size	7.25 x 2.37 x 0.25-0.5 in

<b>3016/9-0</b>	<b>No. 0 (2.0 mm)</b>
0 5 1221 25 130 6	

<b>3016/9-5</b>	<b>No. 5 (3.75 mm)</b>
0 5 1221 25 135 1	

<b>3016/16-0</b>	<b>No. 0 (2.0 mm)</b>
0 5 1221 25 150 4	

<b>3016/16-8</b>	<b>No. 8 (5.0 mm)</b>
0 5 1221 25 158 0	

<b>3016/9-1</b>	<b>No. 1 (2.25 mm)</b>
0 5 1221 25 131 3	

<b>3016/9-6</b>	<b>No. 6 (4.0 mm)</b>
0 5 1221 25 136 8	

<b>3016/16-1</b>	<b>No. 1 (2.25 mm)</b>
0 5 1221 25 151 1	

<b>3016/16-9</b>	<b>No. 9 (5.5 mm)</b>
0 5 1221 25 159 7	

<b>3016/9-2</b>	<b>No. 2 (2.75 mm)</b>
0 5 1221 25 132 0	

<b>3016/9-7</b>	<b>No. 7 (4.5 mm)</b>
0 5 1221 25 137 5	

<b>3016/16-2</b>	<b>No. 2 (2.75 mm)</b>
0 5 1221 25 152 8	

<b>3016/16-10</b>	<b>No. 10 (6.0 mm)</b>
0 5 1221 25 160 3	

<b>3016/9-3</b>	<b>No. 3 (3.25 mm)</b>
0 5 1221 25 133 7	

<b>3016/9-8</b>	<b>No. 8 (5.0 mm)</b>
0 5 1221 25 138 2	

<b>3016/16-3</b>	<b>No. 3 (3.25 mm)</b>
0 5 1221 25 153 5	

<b>3016/16-10.5</b>	<b>No. 10.5 (6.5 mm)</b>
0 5 1221 25 161 0	

<b>3016/9-4</b>	<b>No. 4 (3.5 mm)</b>
0 5 1221 25 134 4	

<b>3016/16-4</b>	<b>No. 4 (3.5 mm)</b>
0 5 1221 25 154 2	

<b>3016/16-11</b>	<b>No. 11 (8.0 mm)</b>
0 5 1221 25 162 7	

<b>3016/16-5</b>	<b>No. 5 (3.75 mm)</b>
0 5 1221 25 155 9	

<b>3016/16-13</b>	<b>No. 13 (9.0 mm)</b>
0 5 1221 25 163 4	

<b>3016/16-6</b>	<b>No. 6 (4.0 mm)</b>
0 5 1221 25 156 6	

<b>3016/16-15</b>	<b>No. 15 (10.0 mm)</b>
0 5 1221 25 164 1	

<b>3016/16-7</b>	<b>No. 7 (4.5 mm)</b>
0 5 1221 25 157 3	



# Bamboo Knitting Needles Takumi®

## Bamboo Circular Knitting Needles "Takumi®"



3016/24-0~19	
Bamboo Circular Knitting Needles "Takumi®" 24 in (61 cm)	
Description	1 pc./pack 3 packs/box
Package Size	9 x 3.12 x 0.25-0.5 in



3016/29-0~19	
Bamboo Circular Knitting Needles "Takumi®" 29 in (74 cm)	
Description	1 pc./pack 3 packs/box
Package Size	9 x 3.12 x 0.25-0.5 in

3016/24-0 No. 0 (2.0 mm)

0 5 1221 25200 6

3016/24-9 No. 9 (5.5 mm)

0 5 1221 25209 9

3016/29-0 No.0 (2.0 mm)

0 5 1221 25300 3

3016/29-9 No.9 (5.5 mm)

0 5 1221 25309 6

3016/24-1 No. 1 (2.25 mm)

0 5 1221 25201 3

3016/24-10 No.10 (6.0 mm)

0 5 1221 25210 5

3016/29-1 No. 1 (2.25 mm)

0 5 1221 25301 0

3016/29-10 No. 10 (6.0 mm)

0 5 1221 25310 2

3016/24-2 No. 2 (2.75 mm)

0 5 1221 25202 0

3016/24-10.5 No. 10.5 (6.5 mm)

0 5 1221 25211 2

3016/29-2 No. 2 (2.75 mm)

0 5 1221 25302 7

3016/29-10.5 No. 10.5 (6.5 mm)

0 5 1221 25311 9

3016/24-3 No. 3 (3.25 mm)

0 5 1221 25203 7

3016/24-11 No.11 (8.0 mm)

0 5 1221 25212 9

3016/29-3 No. 3 (3.25 mm)

0 5 1221 25303 4

3016/29-11 No. 11 (8.0 mm)

0 5 1221 25312 6

3016/24-4 No. 4 (3.5 mm)

0 5 1221 25204 4

3016/24-13 No.13 (9.0 mm)

0 5 1221 25213 6

3016/29-4 No. 4 (3.5 mm)

0 5 1221 25304 1

3016/29-13 No. 13 (9.0 mm)

0 5 1221 25313 3

3016/24-5 No. 5 (3.75 mm)

0 5 1221 25205 1

3016/24-15 No.15 (10.0 mm)

0 5 1221 25214 3

3016/29-5 No. 5 (3.75 mm)

0 5 1221 25305 8

3016/29-15 No. 15 (10.0 mm)

0 5 1221 25314 0

3016/24-6 No. 6 (4.0 mm)

0 5 1221 25206 8

3016/24-17 No.17 (12.75 mm)

0 5 1221 28215 7

3016/29-6 No. 6 (4.0 mm)

0 5 1221 25306 5

3016/29-17 No. 17 (12.75 mm)

0 5 1221 28315 4

3016/24-7 No. 7 (4.5 mm)

0 5 1221 25207 5

3016/24-19 No.19 (15 mm)

0 5 1221 28216 4

3016/29-7 No. 7 (4.5 mm)

0 5 1221 25307 2

3016/29-19 No. 19 (15 mm)

0 5 1221 28316 1

3016/24-8 No. 8 (5.0 mm)

0 5 1221 25208 2

3016/29-8 No. 8 (5.0 mm)

0 5 1221 25308 9



# Bamboo Knitting Needles Takumi®

## Bamboo Circular Knitting Needles "Takumi®"



3016/36-0~19	
Bamboo Circular Knitting Needles "Takumi®" 36 in (91 cm)	
Description	1 pcs./pack 3 packs/box
Package Size	9 x 3.12 x 0.25-0.5 in



3016/48-0~10.5	
Bamboo Circular Knitting Needles "Takumi®" 48 in (120 cm)	
Description	1 pcs./pack 3 packs/box
Package Size	9 x 3.12 x 0.25-0.5 in

3016/36-0	No. 0 (2.0 mm)
0 51221 25330 0	

3016/36-9	No. 9 (5.5 mm)
0 51221 25339 3	

3016/48-0	No.0 (2.0 mm)
0 51221 25380 5	

3016/48-6	No.6 (4.0 mm)
0 51221 25386 7	

3016/36-1	No. 1 (2.25 mm)
0 51221 25331 7	

3016/36-10	No.10 (6.0 mm)
0 51221 25340 9	

3016/48-1	No. 1 (2.25 mm)
0 51221 25381 2	

3016/48-7	No. 7 (4.5 mm)
0 51221 25387 4	

3016/36-2	No. 2 (2.75 mm)
0 51221 25332 4	

3016/36-10.5	No. 10.5 (6.5 mm)
0 51221 25341 6	

3016/48-2	No. 2 (2.75 mm)
0 51221 25382 9	

3016/48-8	No. 8 (5.0 mm)
0 51221 25388 1	

3016/36-3	No. 3 (3.25 mm)
0 51221 25333 1	

3016/36-11	No.11 (8.0 mm)
0 51221 25342 3	

3016/48-3	No. 3 (3.25 mm)
0 51221 25383 6	

3016/48-9	No. 9 (5.5 mm)
0 51221 25389 8	

3016/36-4	No. 4 (3.5 mm)
0 51221 25334 8	

3016/36-13	No.13 (9.0 mm)
0 51221 25343 0	

3016/48-4	No. 4 (3.5 mm)
0 51221 25384 3	

3016/48-10	No. 10 (6.0 mm)
0 51221 25390 4	

3016/36-5	No. 5 (3.75 mm)
0 51221 25335 5	

3016/36-15	No.15 (10.0 mm)
0 51221 25345 4	

3016/48-5	No. 5 (3.75 mm)
0 51221 25385 0	

3016/48-10.5	No. 10.5 (6.5 mm)
0 51221 25391 1	

3016/36-6	No. 6 (4.0 mm)
0 51221 25336 2	

3016/36-17	No.17 (12.75 mm)
0 51221 28346 8	

3016/36-7	No. 7 (4.5 mm)
0 51221 25337 9	

3016/36-19	No.19 (15 mm)
0 51221 28347 5	

3016/36-8	No. 8 (5.0 mm)
0 51221 25338 6	



# Bamboo Knitting Needles Takumi®

## "Takumi®" Bamboo Interchangeable Circular Knitting Needles

**3633-3644**  
**Takumi®** Bamboo Interchangeable Circular Knitting Needles

2 pcs./ pack	3 packs
Package Size	7.5 x 2.5 x 0.5 in

<b>3633</b>	
No. 3 (3.25 mm)	0 5 1221 73633 9
<b>3634</b>	
No. 4 (3.5 mm)	0 5 1221 73634 6
<b>3635</b>	
No. 5 (3.75 mm)	0 5 1221 73635 3
<b>3636</b>	
No. 6 (4.0 mm)	0 5 1221 73636 0
<b>3637</b>	
No. 7 (4.5 mm)	0 5 1221 73637 7
<b>3638</b>	
No. 8 (5.0 mm)	0 5 1221 73638 4
<b>3639</b>	
No. 9 (5.5 mm)	0 5 1221 73639 1
<b>3640</b>	
No. 10 (6.0 mm)	0 5 1221 73640 7
<b>3641</b>	
No. 10.5 (6.5 mm)	0 5 1221 73641 4
<b>3642</b>	
No. 11 (8.0 mm)	0 5 1221 73642 1
<b>3643</b>	
No. 13 (9.0 mm)	0 5 1221 73643 8
<b>3644</b>	
No. 15 (10.0 mm)	0 5 1221 73644 5



**3652**  
**"Takumi®" Bamboo Interchangeable Circular Knitting Case (Pink)**

1 set/box	
Package Size	9 x 6.5 x 1.25 in



**3683**  
**"Takumi®" Combo Interchangeable Circular Knitting Needles**

1 set/box	
Package Size	9 x 6.5 x 1.25 in



**3645-3649**  
**Interchangeable Cords**

1 pcs./ pack	3 packs
Package Size	6 x 3.5 x 0.5 in

<b>3645</b>	
16 in (41 cm)	0 5 1221 73645 2
<b>3646</b>	
24 in (61 cm)	0 5 1221 73646 9
<b>3647</b>	
29 in (74 cm)	0 5 1221 73647 6
<b>3648</b>	
36 in (91 cm)	0 5 1221 73648 3
<b>3649</b>	
48 in (120 cm)	0 5 1221 73649 0



**3650**  
**Interchangeable Cord Connectors**

2 pcs./pack	3 packs/box
Package Size	4.5 x 2 x 0.25 in

**3651**  
**Interchangeable Stoppers**

2 pcs./pack	3 packs/box
Package Size	4.5 x 2 x 0.25 in



# Bamboo Knitting Needles Takumi®

## "Takumi®" Bamboo Interchangeable Tunisian Crochet Hooks

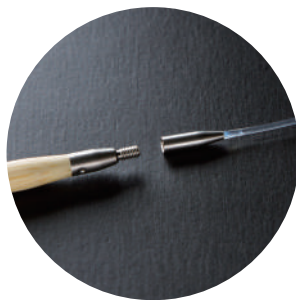

**Art. No. 3684**  
**Interchangeable Tunisian Crochet Hook "Takumi®" Combo Set**

1 pcs./pack	3 packs/box
Package Size	9.5 x 7 x 1 in



3690 3691 3692 3693 3694



3695 3696 3697 3698

**3690-3698**  
**Interchangeable Tunisian Crochet Hook "Takumi®" Combo Set**

1 pcs./ pack	3 packs/box
Package Size	9x 2.5 x 0.12 in

<b>3690</b>	
E (3.5 mm)	0 5 1221 73690 2
<b>3691</b>	
F (3.75 mm)	0 5 1221 73691 9
<b>3692</b>	
G (4.0 mm)	0 5 1221 73692 6
<b>3693</b>	
7 (4.5 mm)	0 5 1221 73693 3
<b>3694</b>	
H (5.0 mm)	0 5 1221 73694 0
<b>3695</b>	
I (5.5 mm)	0 5 1221 73695 7
<b>3696</b>	
J (6.0 mm)	0 5 1221 73696 4
<b>3697</b>	
K (6.5 mm)	0 5 1221 73697 1
<b>3698</b>	
L (8.0 mm)	0 5 1221 73698 8



# Crochet Hooks

## Soft Touch Steel Crochet Hooks

The sophisticated design gives you the best crocheting experience

With these easy, soft-touch grips, your hands won't feel fatigue after long hours of crocheting.

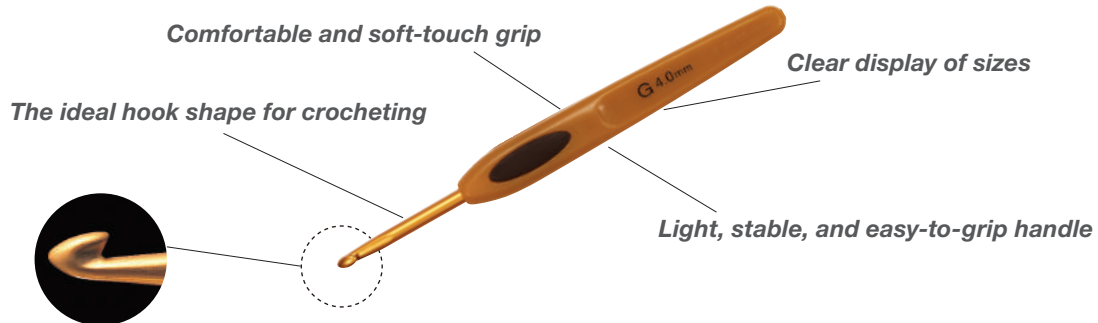

1002/B-1010/J Soft Touch Crochet Hook	
1 pc./pack	3 packs/box
Package Size	7.5 x 1.5 x 0.5 in
<b>1002/B</b>	
2.25 mm	0 51221 11452 6
<b>1003/C</b>	
2.75 mm	0 51221 11410 6
<b>1004/D</b>	
3.25 mm	0 51221 11411 3
<b>1005/E</b>	
3.5 mm	0 51221 11412 0
<b>1006/F</b>	
3.75 mm	0 51221 11413 7
<b>1007/G</b>	
4.0 mm	0 51221 11414 4
<b>1032/7</b>	
4.5 mm	0 51221 11455 7
<b>1008/H</b>	
5.0 mm	0 51221 11415 1
<b>1009/I</b>	
5.5 mm	0 51221 11416 8
<b>1010/J</b>	
6.0 mm	0 51221 11417 5

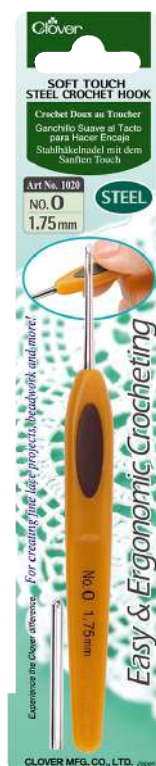

1020-1027 Soft Touch Crochet Hook	
1 pc./pack	3 packs/box
Package Size	7.5 x 1.5 x 0.5 in
<b>1020</b>	
No. 0 (1.75 mm)	0 51221 11430 4
<b>1021</b>	
No. 2 (1.50 mm)	0 51221 11431 1
<b>1022</b>	
No. 4 (1.25 mm)	0 51221 11432 8
<b>1023</b>	
No. 6 (1.00 mm)	0 51221 11433 5
<b>1024</b>	
No. 8 (0.90 mm)	0 51221 11434 2
<b>1025</b>	
No. 10 (0.75 mm)	0 51221 11435 9
<b>1026</b>	
No. 12 (0.60 mm)	0 51221 11436 6
<b>1027</b>	
No. 14 (0.50 mm)	0 51221 11437 3



# Crochet Hooks

## Amour Crochet Hooks

*Amour crochet hooks are so comfortable to use that you won't want to stop.*

With a soft, ergonomic handle and an ultra-smooth hook and shaft, crochet is always smooth and even.



### Why Amour crochet hooks are the best choice:

#### Carefully designed hook

*Easy to pull the yarn through the stitches and the stitches stay on the hook*

Stitches don't slip off the hook making it easy to pick up stitches and pull the yarn through the stitches.

It is designed to make basic crocheting smooth and accurate.

<When picking up stitches>

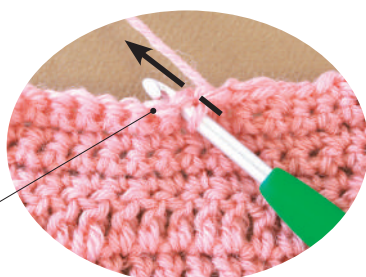

The small hook passes through the stitches easily

<When pulling the yarn through the stitches>

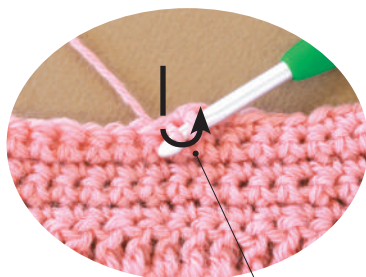

The deep hook holds the yarn securely

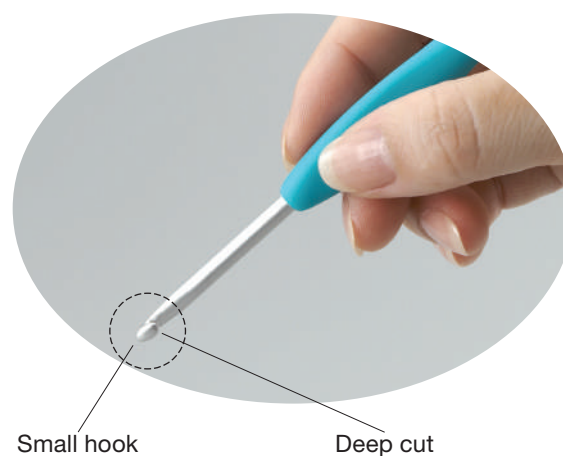

Small hook

Deep cut

#### Hand-friendly grip

*3D design achieves an easy grip*

Grips with a 3D curve fit your fingertips comfortably. These perfectly fitting handles require no extra power, allowing you to crochet tirelessly.

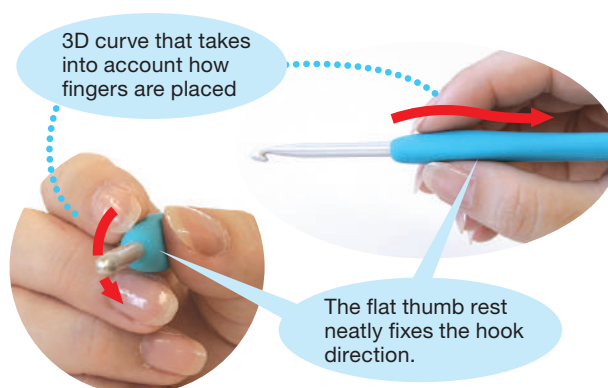

#### Soft and nonslip material

The entire grip is made of nonslip material to serve many different crocheting styles. It has a comfortable and soft touch.

# Crochet Hooks



1040/B      1041/C      1042/D      1043/E      1044/F



1045/G      1046/7      1047/H      1048/I      1049/J



1053/K      1054      1055/L      1056/MN      1057/NP



1058      1059/PQ



3672

<b>1040/B-1049/J</b>	
<b>Amour Crochet Hook</b>	
1 pc./pack	3 packs/box
Package Size	7.5 x 1.5 x 0.5 in
<b>1040/B</b>	
<b>B (2.25 mm)</b>	0 51221 71040 7
<b>1041/C</b>	
<b>C (2.75 mm)</b>	0 51221 71041 4
<b>1042/D</b>	
<b>D (3.25 mm)</b>	0 51221 71042 1
<b>1043/E</b>	
<b>E (3.5 mm)</b>	0 51221 71043 8
<b>1044/F</b>	
<b>F (3.75 mm)</b>	0 51221 71044 5
<b>1045 G</b>	
<b>G (4.0 mm)</b>	0 51221 71045 2
<b>1046/7</b>	
<b>7 (4.5 mm)</b>	0 51221 71046 9
<b>1047/H</b>	
<b>H (5.0 mm)</b>	0 51221 71047 6
<b>1048/I</b>	
<b>I (5.5 mm)</b>	0 51221 71048 3
<b>1049/J</b>	
<b>J (6.0 mm)</b>	0 51221 71049 0

<b>1053-1059</b>	
<b>Amour Crochet Hook</b>	
1 pc./pack	3 packs/box
Package Size	8 x 1.5 x 1 in
<b>1053/K</b>	
<b>K (6.5 mm)</b>	0 51221 71053 7
<b>1054</b>	
<b>7.0 mm</b>	0 51221 71054 4
<b>1055/L</b>	
<b>L (8.0 mm)</b>	0 51221 71055 1
<b>1056/ MN</b>	
<b>MN (9.0 mm)</b>	0 51221 71056 8
<b>1057/NP</b>	
<b>NP (10.0 mm)</b>	0 51221 71057 5
<b>1058</b>	
<b>12.0 mm</b>	0 51221 71058 2
<b>1059/PQ</b>	
<b>PQ (15.0 mm)</b>	0 51221 71059 9

<b>3672</b>	
<b>Amour Crochet Hook Set</b>	
1 set/box	
Package Size	7.5 x 1.5 x 0.5 in

# Crochet Hooks

Why Amour crochet hooks are the best choice:

## 1. Easy-to-Use Crochet Hook

The hook is designed to prevent thread from slipping, and making picking up and pulling through of stitches easier.

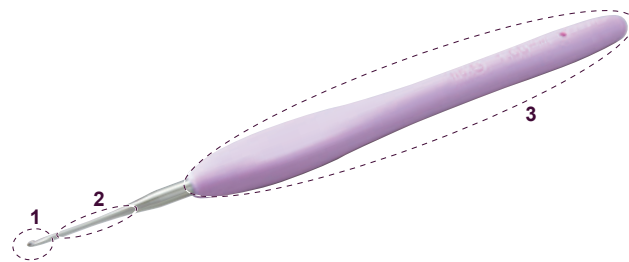
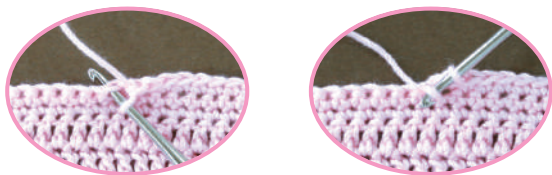

3. Soft, non-slip material is easy to grip reducing hand fatigue.

The three-dimensional curves on the grip fit your fingertips naturally. This naturally fitting design prevents you from gripping the needle unnecessarily tightly, stopping your hand from getting tired easily.

## 2. Beautiful even stitches because of long, uniform diameter shafts.



Beautifully aligned stitches

Uniform thickness of the wider part of the shaft will keep the stitches neatly aligned.

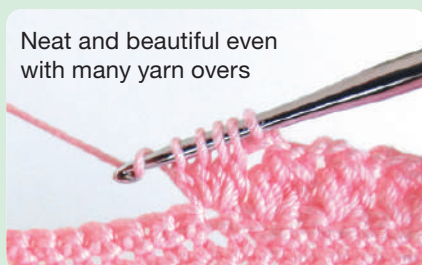

Neat and beautiful even with many yarn overs

Stitches with many yarn overs can be made beautifully as well.

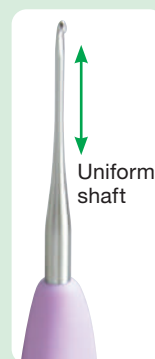

Uniform shaft



Shaft

<b>1220-1226</b>	
<b>Amour Steel Crochet Hook</b>	
1 pc./pack	3 packs/box
Package Size	7.5 x 1.5 x 0.5 in
<b>1220</b>	
No. 0 (1.75 mm)	
<b>1221</b>	
No. 2 (1.50 mm)	
<b>1222</b>	
No. 4 (1.25 mm)	
<b>1223</b>	
No. 6 (1.00 mm)	
<b>1224</b>	
No. 8 (0.90 mm)	
<b>1225</b>	
No. 10 (0.75 mm)	
<b>1226</b>	
No. 12 (0.60 mm)	
<b>3675</b>	
<b>Amour Steel Crochet Hook Set</b>	
1 set/box	
Package Size	7.5 x 4 x 1 in





# Crochet Hooks



1305/G -1308/J	
Double Ended Tunisian Crochet Hook	
1 pc./pack	3 packs/box
Package Size	8.25 x 2.5 x 0.12 in
1305/G	
G (4.0 mm)	0 51221 11805 0
1306/H	
H (5.0 mm)	0 51221 11806 7
1307/I	
I (5.5 mm)	0 51221 11807 4
1308/J	
J (6.0 mm)	0 51221 11808 1



## Fun & Fast, Crocheting in the Round! Simply work in the round using the 2 hooks and alternating the 2 yarns.

### • Example of circular knitting

Simply work in rounds in a spiral using the two hooks and alternating the two yarns. It's easy to use and you can knit non-stop.



Use two yarns and knit alternatively. The crocheted fabric is circular.

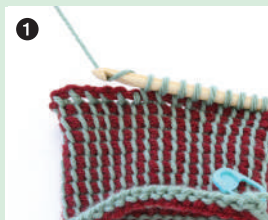

1 Pick up the stitch (the warp yarn of the preceding row or the back bump of chain stitch) with the left hook.



2 Use the right hook to stitch the other yarn and continue.

Enjoy different designs by combining yarns of different colours.

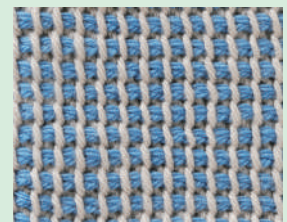

Plain Tunisian stitch

### • Example of flat knitting

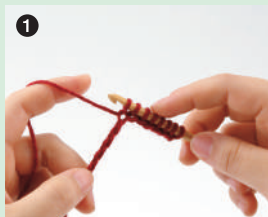

1 Pick up the stitch (the warp yarn of the preceding row or the back bump of chain stitch) with the left hook.



2 Pull up the yarn through the stitches from the left to the right.

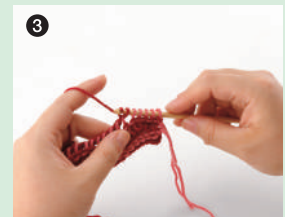

3 Repeat 1 and 2.



# Knitting Accessories

## "To Finish"

Darning needles are essential for hand-knitting, including darning and grafting. Yarn-friendly darning needles that prevent yarns from splitting with their rounded tips.

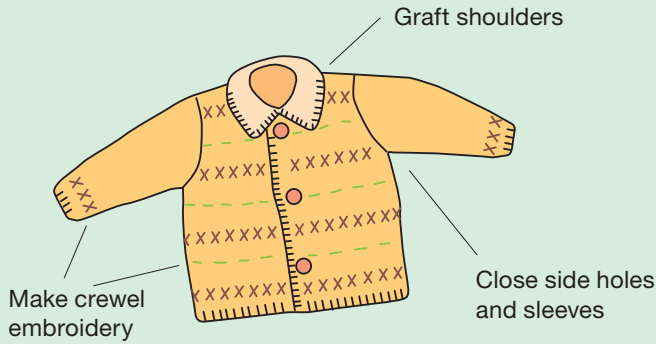

<b>219</b>	
<b>Jumbo Tapestry Needles Bent Tip</b>	
2 needles/pack	5 packs/box
Package Size	5.75 x 2 x 0.12 in



<b>339</b>	
<b>Darning Needle Set</b>	
3 needles/pack	3 packs/box
Package Size	6.25 x 2.12 x 0.75 in

A darning needle set in a cute knitting needle shaped case.  
Needle sizes:  
No. 13, 17, 20



<b>340</b>	
<b>Jumbo Darning Needle Set</b>	
2 needles/pack	3 packs/box
Package Size	6.25 x 2.12 x 0.75 in

A darning needle set in a cute knitting needle shaped case.  
Needle size: 2.50 x 70.0 mm



<b>3121</b>	
<b>Darning Needle Set (Bent tip)</b>	
3 needles/pack	3 packs/box
Package Size	6.25 x 2.12 x 0.75 in

A darning needle set in a cute knitting needle shaped case.  
Needle sizes:  
No. 15(2 pcs.), No. 17(1 pc.)



<b>3168</b>	
<b>Lace Darning Needle Set</b>	
3 needles/pack	3 packs/box
Package Size	6.25 x 2.12 x 0.75 in

Easy and convenient carrying case with a screw on cap stores needles neatly.  
Needle sizes:  
No. 20, 22 (Bent tip) / No. 24

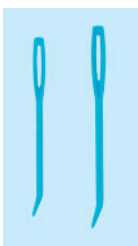

<b>3113</b>	
<b>Super Jumbo Tapestry Needle Set</b>	
2 needles/pack	3 packs/box
Package Size	6.12 x 2 x 0.12 in

Large eye makes for easy threading of long-pile or extremely thick woolen yarn.  
The tip of the needle is slightly curved, making it easier to pick up stitches.

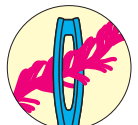
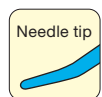

<b>3160</b>	
<b>Darning Needles with Latch Hook Eye</b>	
2 needles/pack	3 packs/box
Package Size	5.25 x 2.75 x 0.67 in

Hook allows for easy threading of multi-ply and bulky yarns.

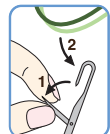



# Knitting Accessories

## Threader made specially for knitting yarn

Thread darning needles easily.

This plate-like solid threader with a large hole is very convenient when using threads that are difficult to thread, such as hard-twist lace thread and fancy yarn.





**3142**  
**Clover Yarn Threader**



1 pc./pack	3 packs/box
Package Size	0.62 x 2.75 x 5.25 in

Thread yarns easily!

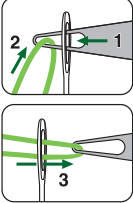





**3114**  
**Antique Yarn Threader**



1 pc./pack	3 packs/box
Package Size	5.125 x 2.75 x .125 in

Antique designed threader for yarn and cotton lace.



**Hold fabrics temporarily with marking pins before finishing with a mattress stitch or by grafting.**

Large head keeps the pin in place

Long shaft makes it easy for you to pin thick fabrics

Pin and hold fabrics before closing side holes, grafting shoulder parts and connecting sleeves.

Use special marking pins for knitting which are long and have a rounded tip.

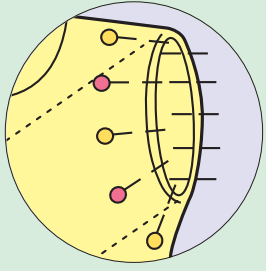

Rounded tip prevents yarns from splitting



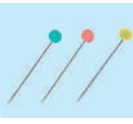

**325**  
**Marking Pins for Knitting**



10 pins/pack	3 packs/box
Package Size	5 x 3 x .375 in

Marking pins with a blunt tip will not split yarns.

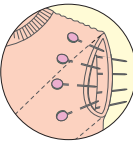

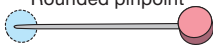

Rounded pinpoint





**3143**  
**Bamboo Marking Pins**



10 pins/pack	3 packs/box
Package Size	7.62 x 2.75 x .375 in

Long pins for thick knitted fabrics.  
Length: Approx. 7 cm  
Pins made from the same materials as the Bamboo Knitting Needles "Takumi".





**3163**  
**Fork Blocking Pins**



40 pins./pack	3 packs/box
Package Size	3 x 3 x 1.83 in

U-Pin for secure pinning and easy removal.

Iron smoothly with fork-shaped curved pins.

**Block knitted garments and sleeves by steaming**

Place and pin the knitted fabric on an ironing board and steam. Leave some space (2-3 cm) between the iron and the fabric while steaming. Stitches and rounded edges will have a neat and beautiful finish.

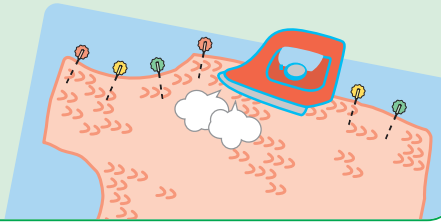

# Knitting Accessories



**3105**  
**Yarn Cutter Pendant (Antique Gold)**

**3106**  
**Yarn Cutter Pendant (Antique Silver)**

1 pc./pack	3 packs/box
Package Size	5 x 2.5 x 0.31 in

Yarn can be cut using any of the grooves. Rotary cutting blade is integrated with pendant, making it safe to use.

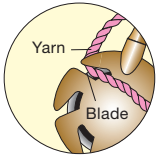

**349**  
**Yarn Guide (Large)**

1 pc./pack	3 packs/box
Package Size	5 x 2.16 x 0.62 in



Passing the yarn through the guide allows you to smoothly separate and knit two or more yarns for stranded knitting or color work. The cover can be opened and closed for easy insertion and removal of yarn. There is no need to worry about yarn slipping off during knitting.



Easy-to-fit open ring  
 Inner diameter when open:  
 approx. 45 (to 48) mm



**328**  
**Knitting Register**

1 pc./pack	3 packs/box
Package Size	5 x 1.9 x 0.59 in

A convenient register that can be inserted onto a straight knitting needle.

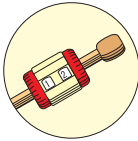

**348**  
**Yarn Guide**

1 pc./pack	3 packs/box
Package Size	5 x 2.16 x 0.78 in

A convenient ring type yarn guide.

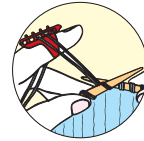

**3118**  
**Mini Knitting Counter**

1 pc./pack	3 packs/box
Package Size	6 x 2.75 x 0.39 in

Track the number of knitted stitches and rows. Pendant style counter.



**3164**  
**Pattern Chart Marker Set**

1 set/pack	3 packs/box
Package Size	14.37 x 4.5 x 0.09 in

- Slip the Pattern Chart Marker onto the chart and hold in place with the attached magnet. Chart Marker moves easily to the next row as you work your pattern.
- You can use it as a book-mark for books or magazines.

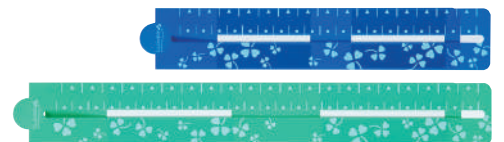

**336**  
**Knitting Counter**

1 pc./pack	3 packs/box
Package Size	5 x 2.5 x 0.59 in

Track the number of knitted stitches and rows with a push of a button.

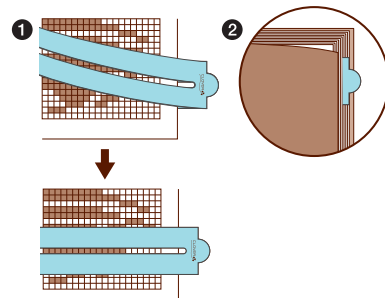

# Knitting Accessories



## 3003 Knitting Accessory Set



1 set/pack	3 packs/box
Package Size	8.26 x 4.33 x 0.59 in

Basic knitting tools in handy compact case.

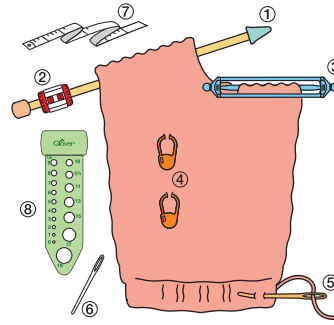

- Set contains:
- ① Point Protectors (Large): 2 pcs.
  - Point Protectors (Small): 2 pcs.
  - ② Knitting Register: 1 pc.
  - ③ Double-Ended Stitch Holders (Small): 2 pcs.
  - ④ Locking Stitch Makers: 20 pcs.
  - ⑤ Jumbo Tapestry Needle: 1 pc.
  - ⑥ Tapestry Needle (No. 17): 1 pc.
  - ⑦ Tape Measure (1.5 m): 1 pc.
  - ⑧ Knitting Needle Gauge: 1 pc.

### For Aran patterns and other cross stitches



## 341 Cable Stitch Holders (U-Shaped)



3 pcs./pack	3 packs/box
Package Size	6.29 x 1.96 x 0.39 in

Designed to hold stitches at the U-shaped area. For regular size yarns.

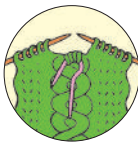

## 330 Cable Stitch Holders



3 pcs./pack	3 packs/box
Package Size	4.8 x 2.55 x 0.39 in

Standard type for smooth knitting. Content: Large, Medium, Small 1 each.



## 3008 Jumbo Cable Stitch Holder Set "U"



2 pcs./pack	3 packs/box
Package Size	6.49 x 2.16 x 0.51 in

Cable Stitch Holder for ultra thick yarns. U-shaped design prevents stitches from dropping. Small: 8 - 10 mm Large: 10 - 15 mm

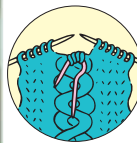

### Knit braid patterns

Convenient for braiding with multiple colors.



Keep yarns at the dent to prevent them from coming loose.

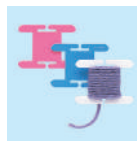

## 332 Knitting Bobbin Set



6 pcs./pack	3 packs/box
Package Size	5.11 x 2.55 x 0.39 in

Convenient for knitting with multi-colored yarns.



# Knitting Accessories

To transfer stitches onto the Double-Ended Stitch Holder, remove either end cap of the elastic band from the double-point needle, slip stitches onto the Holder, then replace the end cap.

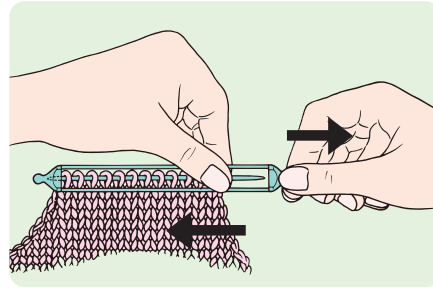
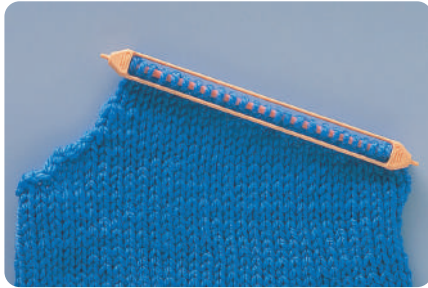

Position the cap so that it won't get in the way while grafting (for large and jumbo sized needles).

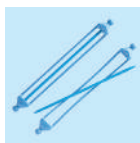

Length:  
5 1/4 in

<b>351</b>	
<b>Double-Ended Stitch Holder (Small)</b>	
0 51221 35602 5	
2 pcs./pack	3 packs/box
Package Size 7.67 x 1.96 x 0.19 in	

Needle size: 2- 7

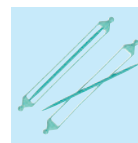

Length:  
5 1/4 in

<b>3006</b>	
<b>Double-Ended Stitch Holder (Medium)</b>	
0 51221 35606 3	
2 pcs./pack	3 packs/box
Package Size 7.75 x 1.96 x 0.35 in	

Needle size: 5-11



Length:  
6 1/2 in

<b>352</b>	
<b>Double-Ended Stitch Holder (Large)</b>	
0 51221 35603 2	
2 pcs./pack	3 packs/box
Package Size 7.67 x 1.96 x 0.19 in	

Needle size: 5-11

The extended length is suitable for works with many stitches.

Stitch holder with soft, pliable cord is a convenient way to store your circular work. Keeps the shape without compromising the stitches. Length of cord is adjustable depending on the number of stitches to be held.



<b>3161</b>	
<b>Circular Stitch Holder (Short)</b>	
0 51221 73161 7	
1 pc./pack	3 packs/box
Package Size 5.11 x 3.93 x 0.47 in	

For Circular Knitting Needles:  
9 - 16 in



<b>3162</b>	
<b>Circular Stitch Holder (Long)</b>	
0 51221 73162 4	
1 pc./pack	3 packs/box
Package Size 5.11 x 3.93 x 0.47 in	

For Circular Knitting Needles:  
24 - 36 in

# Knitting Accessories

## Knit with markings

Are you counting stitches and rows over and over again? Count no more by simply placing these markers every 10-20 rows or where you have increased or decreased stitches. Then place stitch ring markers at the beginning of patterns for a smooth knitting experience.

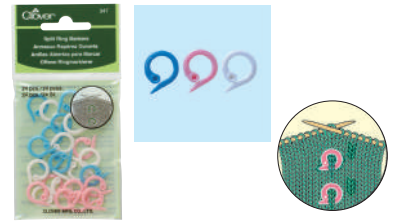
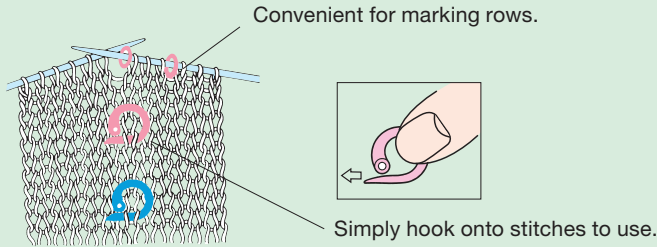

**347**  
**Split Ring Markers**

24 pcs./pack	3 packs/box
Package Size	5 x 2.62 x 0.12 in

Securely locks onto knitted stitches. One-touch action for placement and removal.

The round plastic rings in two sizes are slipped on the needles to mark the beginning and ending of pattern stitches, increasing, decreasing on the garment.

**329**  
**Stitch Ring Markers**

10 small, 20 large rings/pack	3 packs/box
Package Size	5 x 2.62 x 0.12 in

Small for needle size: 0-5  
Large for needle size: 5-11

**354**  
**Jumbo Stitch Ring Markers**

10 small, 10 large rings/pack	3 packs/box
Package Size	5 x 2.62 x 0.12 in

A thin ring marker for uniform knitting.  
Small for needle size: 11-15  
Large for needle size: 17-35

**3107**  
**Soft Stitch Ring Markers**

10 small, 20 large rings/pack	3 packs/box
Package Size	5 x 2.62 x 0.12 in

Small for needle size: 0-5  
Large for needle size: 5-11

**3108**  
**Soft Jumbo Stitch Ring Markers**

10 small, 20 large rings/pack	3 packs/box
Package Size	5 x 2.62 x 0.12 in

Small for needle size: 11-15  
Large for needle size: 17-35

The Stitch Markers Triangle have a specific triangle shape that allows the knitting needle tips to slip in easily when passing the markers from one needle to another.



**3148**  
**Stitch Markers Triangle (XS)**

24 pcs./pack	3 packs/box
Package Size	5 x 2.55 x 0.11 in

Needle size: 0-4



**3149**  
**Stitch Markers Triangle (Small)**

16 pcs./pack	3 packs/box
Package Size	5.25 x 2.75 x 0.75 in

Needle size: 5-18



**3150**  
**Stitch Markers Triangle (Medium)**

16 pcs./pack	3 packs/box
Package Size	5.25 x 2.75 x 0.75 in

Needle size: 9-10 1/2

# Knitting Accessories

## Quick Locking Stitch Markers

### Lock-type stitch marker.

It can also be used in the unlocked position. Its undulated design prevents stretching of knitted stitches.



The small size is perfect for fine stitching on socks and laces.



The medium size is ideal for a wide range of projects including accessories and clothes.



The large size is suitable for Cowichan and fancy yarns in which medium-sized markers might be buried.

3030	
Quick Locking Stitch Markers (Small)	
20 pcs./pack	3 packs/box
Package Size	5.12 x 2.62 x 0.12 in

3031	
Quick Locking Stitch Markers (Medium)	
20 pcs./pack	3 packs/box
Package Size	5.12 x 2.62 x 0.18 in

3032	
Quick Locking Stitch Markers (Large)	
12 pcs./pack	3 packs/box
Package Size	5.12 x 2.62 x 0.25 in

3033	
Quick Locking Stitch Marker Set	
1 set/pack	3 packs/box
Package Size	6.25 x 4 x 1 in



### Lock-type stitch marker.

It can also be used in the unlocked position. Its undulated design prevents stretching of knitted stitches. Handy compact case included. Small: 10 pcs./Medium: 20 pcs./Large: 6 pcs.

3034	
Knitting Accessory Set for Beginners	
1 set/pack	3 packs/box
Package Size	6.25 x 4 x 1 in



### Basic accessories in handy compact case.

A convenient starter set with knitting accessories that you'll use frequently.

- Quick Locking Stitch Markers (10 pcs.)
- Soft Stitch Ring Markers (Small: 20 pcs. /Large: 20 pcs.)  
For needle sizes Small: 2.0 mm – 3.75 mm  
Large: 3.75 mm – 8.0 mm
- Point Protectors (2 pcs.)  
For needle sizes: 3.75 mm – 6.5 mm

3035	
Knitting Accessory Set for Socks	
1 set/pack	3 packs/box
Package Size	6.25 x 4 x 1 in



### Useful basic accessories for sock knitting with case.

- Quick Locking Stitch Markers (10 pcs.)
- Soft Stitch Ring Markers (20 pcs.)  
For needle sizes 2.0 mm – 3.75 mm
- Double Pointed Needle Protectors (2 pcs.)  
For needle sizes: 2.0 mm – 3.75 mm
- Darning needles: No. 20, 21



3165	
Locking Stitch Markers with Clip	
6 pcs./pack	3 packs/box
Package Size	6 5/8 x 3 1/4 x 1/3 in

- You can attach notes to stitches!
- Perforated notepad included!

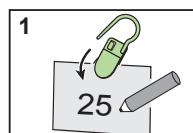

1. Write a note and clip it.

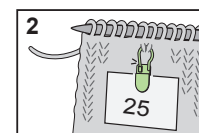

2. Attach to a stitch.



# Knitting Accessories

Lock-type stitch marker that stays in place for worry-free knitting



**353**  
**Locking Stitch Markers**

20 pcs./pack	3 packs/box
Package Size 5 x 2.62 x 0.37 in	

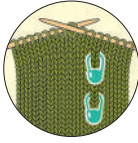

Locks onto knitted stitches for worry-free knitting.

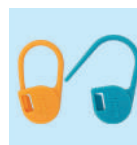

**3109**  
**Jumbo Locking Stitch Markers**

12 pcs./pack	3 packs/box
Package Size 5.12 x 2.5 x 0.37 in	

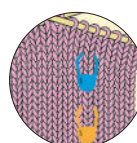

Perfect for super bulky yarn.



**333/S**  
**Point Protectors (Small)**

4 pcs./pack	3 packs/box
Package Size 5 x 2.62 x 0.37 in	

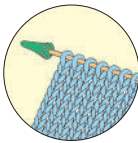

A knitting needle cap to prevent knitted stitches from falling off.  
 Needle size: 0-7



**333/L**  
**Point Protectors (Large)**

4 pcs./pack	3 packs/box
Package Size 5 x 2.62 x 0.5 in	

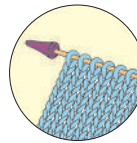

A knitting needle cap to prevent knitted stitches from falling off.  
 Needle size: 6-10 1/2



**3140**  
**Point Protectors and Stopper**

6 pcs./pack	3 packs/box
Package Size 5 x 2.62 x 0.37 in	

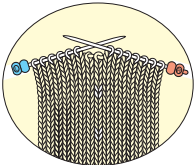

3 pairs of knitting needle caps to prevent stitches from falling off. Cap colours tell you which side of the fabric you are working on!  
 Needle size: 0-10 1/2



**3141**  
**Point Protectors Petit**

4 pcs./pack	3 packs/box
Package Size 5 x 2.62 x 0.37 in	

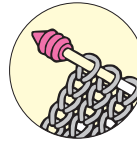

2 pairs of caps that prevents knitted stitches from slipping off. Light and easy to use!  
 Needle size: 0-10 1/2



**3004**  
**Point Protector for Circular Knitting Needles (Small)**

4 pcs./pack	3 packs/box
Package Size 5 x 2.62 x 0.25 in	

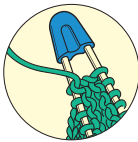

Compactly stores without spreading needles.  
 Needle size: 0-8



**3005**  
**Point Protector for Circular Knitting Needles (Large)**

4 pcs./pack	3 packs/box
Package Size 5 x 2.62 x 0.37 in	

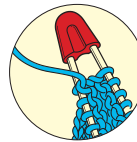

Compactly stores without spreading needles.  
 Needle size: 8-15



**3110**  
**Jumbo Point Protectors (Small)**

4 pcs./pack	3 packs/box
Package Size 4.87 x 2.75 x .87 in	

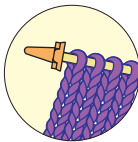

A knitting needle cap to prevent knitted stitches from falling off.  
 Needle size: 11-15



**3112**  
**Jumbo Point Protectors (Large)**

2 pcs./pack	3 packs/box
Package Size 3.37 x 2 x 0.5 in	

Prevents stitches from slipping off knitting needle.  
 For needle sizes: 17-19



# Knitting Accessories

Convenient for storing needles!

**3122**  
**Coil Knitting Needle Holders (Large)**

3 pcs./pack	3 packs/box
Package Size	5 x 2.62 x 0.37 in

Non-slip holder winds around knitting needles.  
Needle size:  
Single Pointed: 10-15  
Double Pointed: 7-10 1/2

**3123**  
**Coil Knitting Needle Holders (Small)**

5 pcs./pack	3 packs/box
Package Size	5 x 2.62 x 0.37 in

Non-slip holder winds around knitting needles.  
Needle size:  
Single Pointed: 2-9  
Double Pointed: 0-6

## Convenient coil-style knitting needle holder

*Perfect for storing and carrying around*

Neatly bundle knitting needles and circular needles that are hard to organize. Convenient for storing and carrying around.

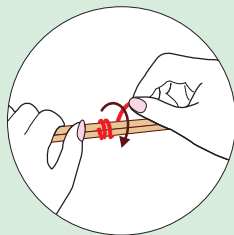

**Bundle easy and tight**

Simply wind the coil around needles to hold them together neatly without slipping.

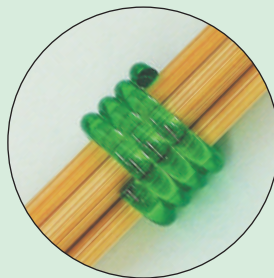

*Use different colors to distinguish between needles*

Use a different color depending on the needle size and length.

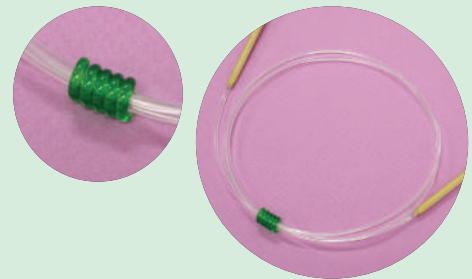

**3200**  
**Swatch Ruler and Needle Gauge**

1 pc./pack	3 packs/box
Package Size	8.66 x 6.38 x 0.06 in

Measure your crochet hook or knitting needle size in US, metric and Japanese standard sizes. The Swatch Ruler allows you to isolate a section of your work to easily count both stitches and rows.

*A multi-purpose tool for knitting and crochet.*

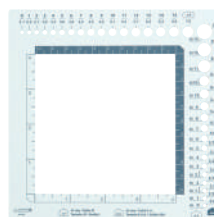

Knitting needle gauge



Crochet hook gauge



Swatch ruler



**3147**  
**Knitting Needle Gauge**

1 pc./pack	3 packs/box
Package Size	5 x 4 x 0.06 in

Measures 20 needles sizes. Needle size: 0-19

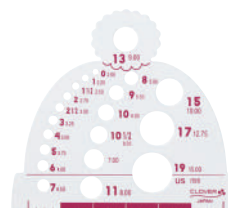

# Knitting Accessories

## For repairing and correcting stitches

“Repair Hook” for fixing incorrect knitted stitches

- Made with “Takumi” quality bamboo

Quickly repair with a smoothly finished surface.

Sharp needle tips that easily undo stitches

Sharp hook tips that easily pass through stitches

Bamboo will prevent the hook from slipping down, even if you accidentally let go of it.

This set contains hooks of two different sizes to serve a variety of situations.

- For cast-on stitches and pick-up stitches

Use as a small crochet hook

- For detangling yarns such as mohair

It's easier if you untangle yarn using the needle tip

- Compact and convenient



**3009**  
Bamboo Knitting Repair Hooks

2 pcs./pack	3 packs/box
Package Size	4.75 x 4.12 x 0.87 in

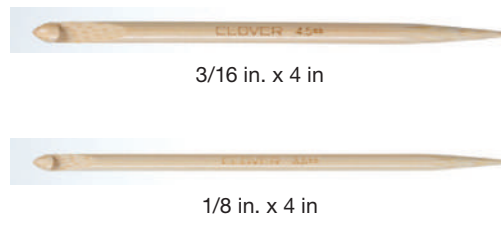

Handy hooks for repairing incorrect stitches. Use the sharp point end to unravel stitches as needed and the hook end to pick up new stitches.

**3120**  
Knitting Needle Tube Case  
<Designer Case> Purple

1 pc./pack	3 packs/box
Package Size	16.12 x 2.37 x 0.37 in

Accommodate knitting needles up to 35 cm long. Knitting accessories can be stored in the bottom case.

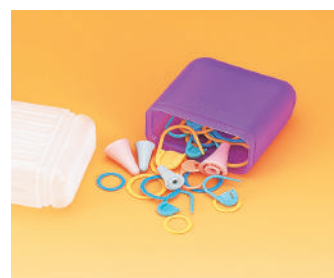

# Black Gold Needles



## Needle Surface : Smooth and rust-resistant

### Polished along the needle shaft

Significantly less friction when compared to standard needles. (Clover comparison).

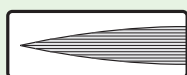

The surface is polished lengthwise.

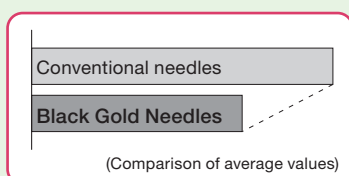

### Special black plating

The special black plating provides outstanding rust resistance compared to conventional nickel plating. (Clover comparison).

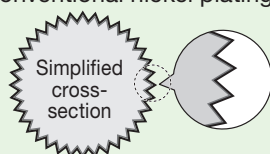

## Needle Tip : Sharp and strong needle tip

Clover's unique polishing process. To strengthen the tip, the first 0.5 mm are polished to a cone shape.



## Needle Eye :

### Shaped for easy threading

Clover's original oval shape adds strength to the eye while lengthening it for easy threading.

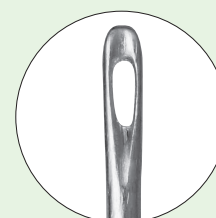

### Gentle on threads

The needle eye is plated with pure gold. The characteristic softness of gold prevents the thread from fraying and breaking.

### Designed to pass smoothly through fabric

Grooved for smooth stitching through fabric.

## Needle Shaft : Bend and break-resistant

The needle shaft uses high-quality steel. Our quenching and tempering processes maximise the strength and elasticity characteristics for the optimum balance.

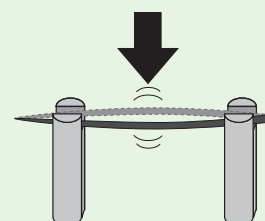



# Black Gold Needles

## Quilting Between



**4960**  
Black Gold Needles  
Quilting Between (No. 9)

0 51221 40336 1

**4961**  
Black Gold Needles  
Quilting Between (No. 10)

0 51221 40337 8

**4962**  
Black Gold Needles  
Quilting Between (No. 12)

0 51221 40338 5

**4963**  
Black Gold Needles  
Quilting Between  
(No. 9/No. 10/No. 12)

0 51221 40339 2

6 needles/pack	3 packs/box
Package Size	6 x 2 x 0.12 in

No. 9	0.53 x 27.0 mm
No. 10	0.46 x 25.4 mm
No. 12	0.53 x 24.4 mm

## Quilting



**4980**  
Black Gold Needles  
Quilting (No. 9)

0 51221 40344 6

**4981**  
Black Gold Needles  
Quilting (No. 10)

0 51221 40345 3

**4982**  
Black Gold Needles  
Quilting (No. 12)

0 51221 40346 0

**4983**  
Black Gold Needles  
Quilting (No. 9/No. 10/No. 12)

0 51221 40347 7

6 needles/pack	3 packs/box
Package Size	6 x 2 x 0.12 in

No. 9	0.56 x 27.3 mm
No. 10	0.56 x 25.8 mm
No. 12	0.51 x 22.7 mm

## Appliqué/Sharps



**4970**  
Black Gold Needles  
Appliqué/Sharps (No. 9)

0 51221 40340 8

**4971**  
Black Gold Needles  
Appliqué/Sharps (No. 10)

0 51221 40341 5

**4972**  
Black Gold Needles  
Appliqué/Sharps (No. 12)

0 51221 40342 2

**4973**  
Black Gold Needles  
Appliqué/Sharps  
(No. 9/No. 10/No. 12)

0 51221 40343 9

6 needles/pack	3 packs/box
Package Size	6 x 2 x 0.12 in

No. 9	0.53 x 34.9 mm
No. 10	0.46 x 33.3 mm
No. 12	0.46 x 28.8 mm



# Sewing, Quilting & Embroidery Needles

## Superior Quality Clover Needles

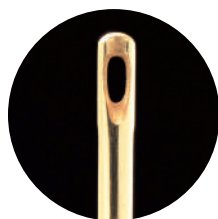

- The needles will glide through fabric smoothly.
- The needle has Gold-Eye plating with a unique elliptical design for easy threading.
- The hardness of steel was obtained through high temperature treatment and tempering, making our needle hard to break or bend.
- Nickel plated for smooth sewing.
- Sharp needle point.



**468/09**  
Quilting Needles  
(No. 9)

0 51221 40105 3

**468/10**  
Quilting Needles  
(No. 10)

0 51221 40103 9

**468/12**  
Quilting Needles  
(No. 12)

0 51221 40101 5

15 needles/pack	12 packs/box
Package Size	5 x 2 x 0.12 in

No. 9	0.56 x 27.3 mm
No. 10	0.56 x 25.8 mm
No. 12	0.51 x 22.7 mm



**496/08**  
Gold Eye Quilting Needles  
Between (No. 8)

0 51221 40332 3

**496/09**  
Gold Eye Quilting Needles  
Between (No. 9)

0 51221 40307 1

**496/10**  
Gold Eye Quilting Needles  
Between (No. 10)

0 51221 40308 8

**496/12**  
Gold Eye Quilting Needles  
Between (No. 12)

0 51221 40309 5

No. 8	0.61 x 28.6 mm
No. 9	0.53 x 27.0 mm
No. 10	0.46 x 25.4 mm
No. 12	0.53 x 24.4 mm



**497/09**  
Gold Eye Appliqué Needles  
(No. 9)

0 51221 40321 7

**497/10**  
Gold Eye Appliqué Needles  
(No. 10)

0 51221 40322 4

**497/12**  
Gold Eye Appliqué Needles  
(No. 12)

0 51221 40323 1

15 needles/pack	12 packs/box
Package Size	5 x 2 x 0.12 in

No. 9	0.53 x 34.9 mm
No. 10	0.46 x 33.3 mm
No. 12	0.46 x 28.8 mm



**2006**  
Self Threading Needles  
(Assorted)

0 51221 40707 9

5 needles/pack	12 packs/box
Package Size	4.12 x 1.75 x 0.12 in

The needles have a built-in threader. Place thread in U-shaped groove and pull down to thread.

0.89 x 42.5 mm
0.76 x 38.0 mm
0.71 x 36.5 mm
0.64 x 42.5 mm
0.64 x 34.9 mm

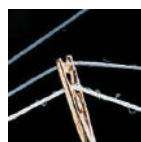

# Sewing, Quilting & Embroidery Needles



**234/18**  
Gold Eye Chenille Needles  
(No. 18)

0 51221 40311 8

**234/20**  
Gold Eye Chenille Needles  
(No. 20)

0 51221 40312 5

**234/22**  
Gold Eye Chenille Needles  
(No. 22)

0 51221 40313 2

**234/24**  
Gold Eye Chenille Needles  
(No. 24)

0 51221 40314 9

6 needles/pack	12 packs/box
Package Size	5 x 2 x 0.12 in



**235**  
Gold Eye Embroidery Needles  
(No. 3 - 9)

0 51221 40315 6

16 needles/pack	12 packs/box
Package Size	5 x 2 x 0.12 in



**238**  
Gold Eye Tapestry Needles  
(No. 18, 20, 22)

0 51221 40318 7

**238/24**  
Gold Eye Tapestry Needles  
(No. 24)

0 51221 40320 0

6 needles/pack	12 packs/box
Package Size	5 x 2 x 0.12 in

238 238/24



**2012**  
Huck Embroidery Needles

0 51221 40712 3

3 needles/pack	12 packs/box
Package Size	5.75 x 2 x 0.25 in

The tip is rounded and curved so cloth can be easily scooped.



# Sewing, Quilting & Embroidery Needles



**2007**  
Sashiko Needles

0 51221 40708 6

8 needles/pack	12 packs/box
Package Size	4.12 x 1.75 x 0.12 in



**2009**  
Sashiko Needles (Long Type)

0 51221 40710 9

3 needles/pack	12 packs/box
Package Size	5.75 x 2 x 0.25 in

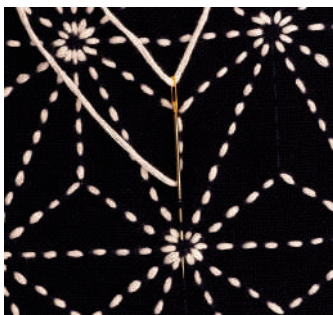
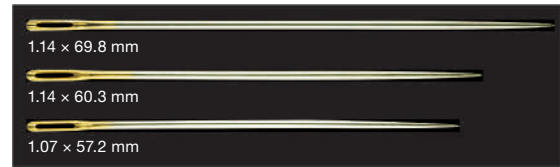
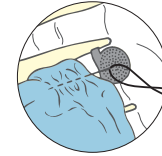

**237/10**  
Gold Eye Sharps Needles (No. 10)

0 51221 40317 0

20 needles/pack	12 packs/box
Package Size	5 x 2 x 0.12 in

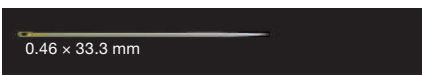

**236**  
Gold Eye Milliners Needles (No. 3, 5, 7, 9)

0 51221 40316 3

16 needles/pack	12 packs/box
Package Size	5 x 2 x 0.12 in

Long needles with round eyes used for: Bonnet and hat making, pleating, ribbon embroidery and embellishing decorations.



**233**  
Beading Needles (No. 10, 13)

0 51221 40310 1

4 needles/pack	12 packs/box
Package Size	5 x 2 x 0.12 in

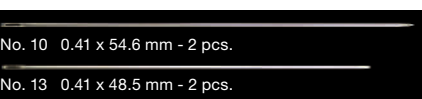

# Sewing, Quilting & Embroidery Needles

Easily repair snags in knitted and woven garments!



<b>2512</b>	
<b>Snag Repair Needles</b>	
2 needles/pack	3 packs/box
Package Size	6 x 2 x 0.07 in

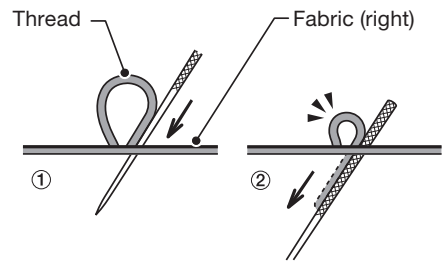
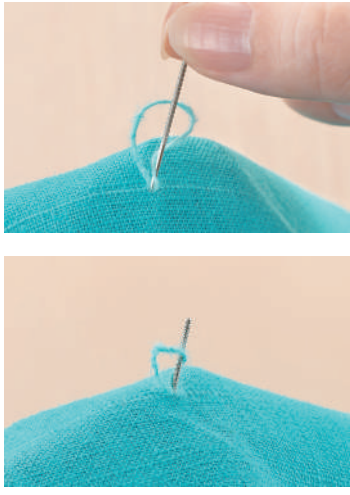
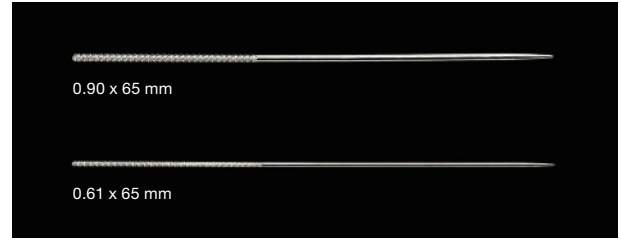

- ① Insert needle in the snag's center.
- ② Pull needle through fabric, capturing entangled thread as you pull.

## Pins

### Wonder Pins



<b>3210</b>	
<b>Wonder Pins (20pcs.)</b>	
20 pcs./pack	3 packs/box
Package Size	4.72 x 2.87 x 0.82 in



### Quick and easy quilt basting

*The curved pin makes scooping and holding the fabric easy.*

- Scoop 3 layers (top, batting and backing) of fabric keeping them spread out flat.

- Tip manufactured to ensure ease of pinning through fabric.

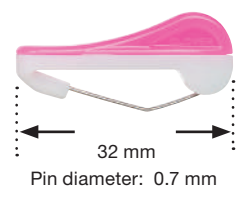

*Simply push the pin down. Easily open and close with one hand.*

Speedy basting and reduced hand fatigue.

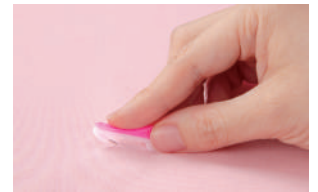

*Can be used in places where Clips cannot reach.*

With closed pins, there's no need to worry about pricking yourself.

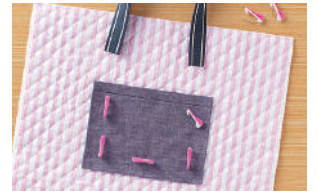

### How to use

1. Scoop up the fabric.
2. Push down the closure, keeping the pin tip upwards and the base of pin touching fabric surface.
3. The pin is secured when it enters the closure.



# Pins

**Heat resistant glass head suited for ironing.**

- 0.5mm thin marking pins.
- Holes are hardly visible and the pins will smoothly pass through fabrics.
- The pins have a fine pointed tip and is made of tough steel.

**Easy-grasp large head and sharp finish!**

The heart-shaped head featured on these pins make them easy to grab, the sharp finish make them easy to use. Their flat head is convenient for machine stitching and ironing.

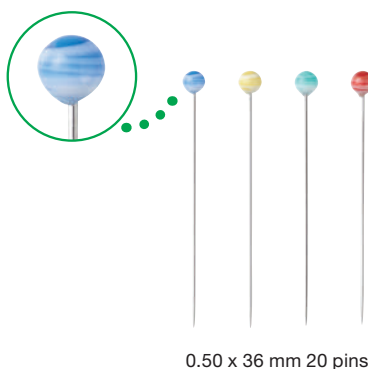

9604	
Heart-Shaped Pins	
1 set/pack	3 packs/box
Package Size	4.5 x 2.5 x 0.16 in

0.55 x 50 mm 20 pins

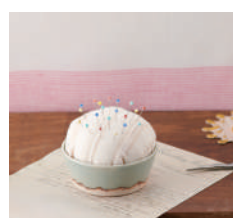

2511	
Marbled Glass Head Pins	
1 set/pack	3 packs/box
Package Size	4.5 x 2.5 x 0.12 in



## Flower Head Pins

Flower Head Pins can hold multiple layers of fabric.  
The flat head is convenient for machine stitching.  
Head is not heat-resistant. Do not apply iron directly. 3 different sizes.



2505	
Flower Head Pins	
0.55 mm	



The pins will hold regular fabric of cotton, linen and wool.

2510	
Flower Head Pins	
0.45 mm	



Superfine-pointed, 0.45mm marking pins will pass through fabric smoothly. The pins will gently hold thin fabrics such as silk, silk crepe, satin and lining fabric.



2506	
Flower Head Pins Boxed	



100 pins/case	3 cases/box
Package Size	4.87 x 3 x 1 in



Iron-proof glass



**232**  
**Patchwork Pins**

0 51221 40304 0

100 pins/case	3 cases/box
Package Size	4.62 x 2.37 x 0.62 in

The needle head is small and the tip is sharp. The pins have very sharp points.

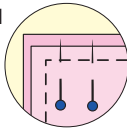

Iron-proof glass



**2501**  
**Silk Pins Boxed**

0 51221 40276 0

100 pins/case	3 cases/box
Package Size	4.87 x 3 x 0.75 in

Suitable for thin fabrics..



Iron-proof glass



**2508**  
**Quilting Pins**

0 51221 40301 9

100 pins/case	3 cases/box
Package Size	4.5 x 2.87 x 0.75 in

Perfectly suited for quilting, as the pins feature a sharp tip and strong shaft.



Iron-proof glass



**2507**  
**Patchwork Pins (Fine)**

0 51221 40300 2

100 pins/case	3 cases/box
Package Size	4.62 x 2.37 x 0.62 in

Extra-fine pins, which smoothly pass through fabric. Useful for precise pinning in delicate piecework and appliqué.



Iron-proof glass



**231**  
**Appliqué Pins**

0 51221 40305 7

150 pins/case	3 cases/box
Package Size	4.62 x 2.37 x 0.62 in

Short pins (2 cm) are perfect for small appliqué work. It will not stick out since it is short.

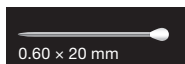

Iron-proof glass



**2509**  
**Quilting Pins (Fine)**

0 51221 40302 6

100 pins/case	3 cases/box
Package Size	4.5 x 2.87 x 0.75 in

Pins smoothly pass through fabric, as the pin tips are thin and sharp.



## Fork Pins



**2401**  
**Fork Pins (70 pcs.)**

0 51221 72401 5

70 pins/case	3 cases/box
Package Size	5.12 x 3 x 0.62 in

**240**  
**Fork Pins (35 pcs.)**

0 51221 40306 4

35 pins/case	3 cases/box
Package Size	5.12 x 3 x 0.62 in

The double pins can pierce and firmly hold slippery lining materials in place. The tip is bent for easy pinning.

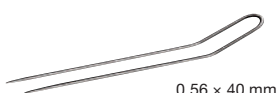

**NP100H**  
**Thumb Tacks with Remover**

0 51221 86842 9

60 pins/case	10 cases/box
Package Size	3.5 x 2 x 0.75 in

# Thimbles

## Natural Fit Leather Thimbles



### Feature 1 Seamless from top to side!



This thimble is made with three-dimensional stitching without seams or stitches in the area where the needle touches, allowing the needle to be pushed from the most convenient spot. Its side is made of full double leather to provide safety.

### Feature 2 Fits the curve of your finger tip naturally!



The unique shape creates a smooth curve from the edge of the fingertip to the middle of the finger. It fits the curve of your finger tip naturally.

<b>6030</b> <b>Natural Fit Leather Thimble (Small)</b> 	
1 pc./pack	3 packs/box
Package Size	5.87 × 2.62 × 0.75 in

<b>6030</b> <b>Natural Fit Leather Thimble (Medium)</b> 	
1 pc./pack	3 packs/box
Package Size	5.87 × 2.62 × 0.75 in

<b>6030</b> <b>Natural Fit Leather Thimble (Large)</b> 	
1 pc./pack	3 packs/box
Package Size	5.87 × 2.62 × 0.75 in

## Protect and Grip Thimbles



<b>6025</b> <b>Protect and Grip Thimble (Small)</b> 	
1 pc./pack	3 packs/box
Package Size	5.87 × 2.62 × 0.75 in



<b>6026</b> <b>Protect and Grip Thimble (Medium)</b> 	
1 pc./pack	3 packs/box
Package Size	5.87 × 2.62 × 0.75 in



<b>6027</b> <b>Protect and Grip Thimble (Large)</b> 	
1 pc./pack	3 packs/box
Package Size	5.87 × 2.62 × 0.75 in

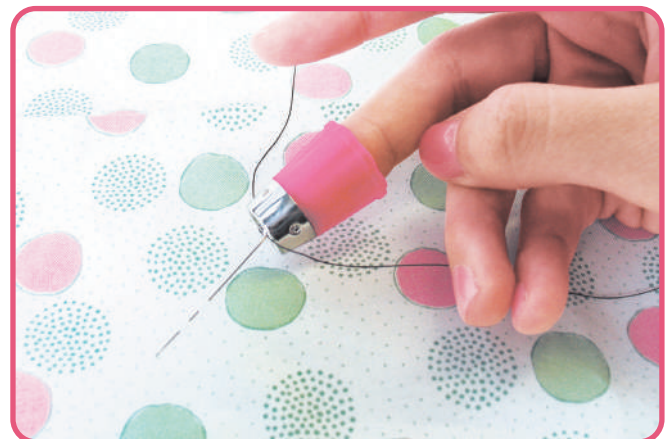

Finger friendly soft rubber, fits gently on your finger without a tight feeling

Excellent breathability with its unique corrugated shape

Dimpled and Ridged

Metal top that can be pushed firmly without danger

50 to 80% lighter than a metal thimble (compared to our conventional product)

Because only a small area touches your finger, this thimble does not make your finger sweaty.





# Thimbles



## 610 Adjustable Ring Thimble



1 pc./pack      3 packs/box  
 Package Size      4.12 x 2.62 x 0.62 in



The metal thimble can be used for thick needles and can be adjusted to any finger size.



## 611 Adjustable Ring Thimble with Plate



1 pc./pack      3 packs/box  
 Package Size      4.12 x 2.62 x 0.62 in

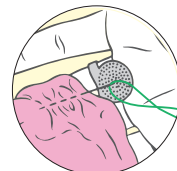

Designed for long-running stitches using a long needle or Sashiko. Adjustable to fit any finger.



## 6014 Coin Thimble (Medium)



1 pc./pack      3 packs/box  
 Package Size      5 x 2 x 0.25 in

Soft leather thimble with coin metal dimpled disk.

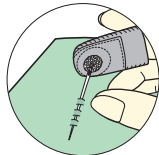

## 616 Double Sided Thimble



1 pc./pack      3 packs/box  
 Package Size      5 x 2 x 0.62 in

Made of soft leather. This thimble has double sided metal "dimpled" tip.



## 6017 Open Sided Thimble (Small)



1 pc./pack      3 packs/box  
 Package Size      5.75 x 2.5 x 0.75 in

Adjustable Open Sided Thimble that fits your finger comfortably. Designed with an open top to keep your finger from perspiring. Dimpled for easy use on needles. Suited for people with long fingernails.



## 612 Leather Thimble



2 pc./pack      3 packs/box  
 Package Size      5 x 2 x 0.5 in

Made of soft leather. The leather thimbles can be adjusted to fit any finger size.

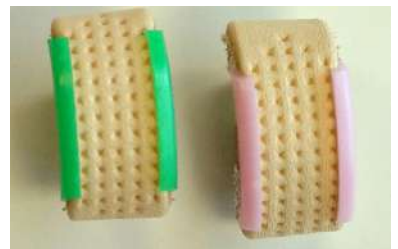

## 6031 Flexible Rubber Thimbles (Medium)



2 pc./pack      3 packs/box  
 Package Size      5 x 2 x 0.25 in

- Flexible for a perfect fit.
- Cooling vents for breathability.



## 6032 Flexible Rubber Thimbles (Large)



2 pc./pack      3 packs/box  
 Package Size      5 x 2 x 0.25 in

- Flexible for a perfect fit.
- Cooling vents for breathability.





# Sewing Notions



480/W	
Tracing Wheel (Serrated Edges)	
1 pc./pack	3 packs/box
Package Size	7.5 x 1.75 x 0.5 in

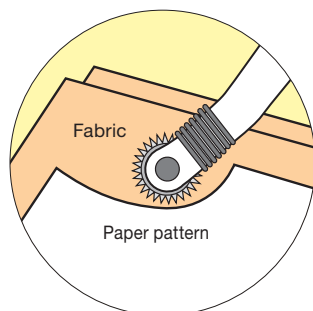

The tracing wheel is used for marking directly onto fabrics. Suitable for marking on thin fabrics.

Trace and mark the holes by rolling the wheel forward along the paper pattern.



481/W	
Tracing Wheel (Blunt Edges)	
1 pc./pack	3 packs/box
Package Size	7.5 x 1.75 x 0.5 in

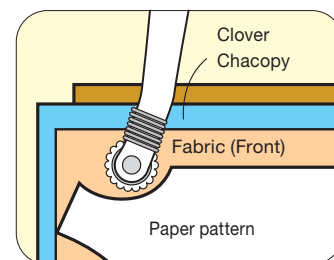

This wheel is used when transferring the pattern to fabrics using Tracing Paper "Clover Chacopy".

The blunt edges will mark the line without tearing the pattern or Chacopy carbon paper.

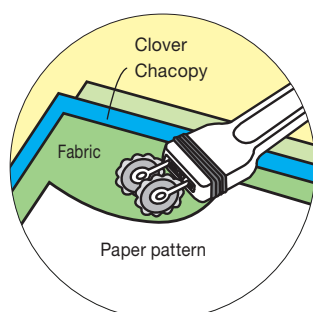

487/W	
Double Tracing Wheel	
1 pc./pack	3 packs/box
Package Size	7.5 x 1.75 x 0.5 in

The Double Tracing Wheel can draw two lines at the same time and the space between each wheel can be changed in units of 5mm.

Seam line and cutting line can be marked at the same time.

The space between the two wheels can be adjusted in units of 5mm between 10-30mm.

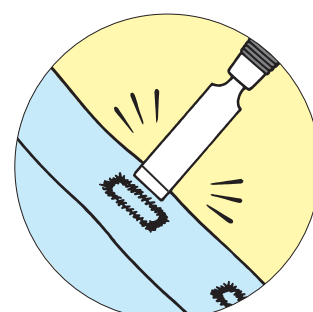

484/W	
Buttonhole Cutter	
1 pc./pack	3 packs/box
Package Size	7.5 x 1.75 x 0.5 in

This cutter makes the job of opening buttonholes or small cuts on fabrics easy.

After stitching a buttonhole, use this cutter to open it by placing and pressing the blade on the beads of the buttonhole vertically.

This cutter is also useful for making small cuts and cutting through curves. (12mm wide)

# Sewing Notions

*The Straight Tailor's Awl and the Tapered Tailor's Awl are convenient for detailed work.*

These awls are used for detailed work such as shaping the edges, feeding the cloth into the sewing machine and untying threads. With a sharp edge like an artillery shell, the awl is suitable for marking and opening holes especially for thick fabrics and leather.



**485/W**  
**Straight Tailor's Awl**

1 pc./pack	3 packs/box
Package Size	7.5 x 1.75 x 0.5 in

Designed for piercing small holes or craft works for doll making.

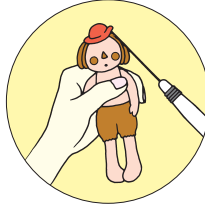

**486/W**  
**Tapered Tailor's Awl**

1 pc./pack	3 packs/box
Package Size	7.5 x 1.75 x 0.5 in

Very useful in punching holes in leather and fabrics, pulling out corners and widening out spaces.



**4880**  
**Curved Tailor's Awl**

1 pc./pack	3 packs/box
Package Size	7.5 x 1.75 x 0.5 in

With its curved tip, this awl is perfect for such tasks as producing curves, feeding cloth, or undoing seams. In addition, the tip has a smooth finish, which makes injury to the cloth or your fingers difficult.



**876**  
**Ball Point Awl**

1 pc./pack	3 packs/box
Package Size	7.5 x 1.75 x 0.5 in

The Ball Point Awl is used for making a hole by carefully stretching the fabric without thread breakage.



*Used to cut threads by placing the longer tip under the thread and pushing forward.*

The seam ripper comes with a small ball to protect it from damaging the fabric.



**482/W**  
**Seam Ripper**

1 pc./pack	3 packs/box
Package Size	7.5 x 1.75 x 0.5 in

Used to cut seams, basting threads or threads under buttons.

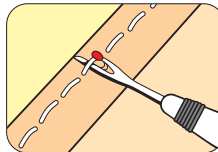

**463**  
**Seam Ripper**

1 pc./pack	3 packs/box
Package Size	7.5 x 1.75 x 0.5 in

Perfect for ripping out seams, cutting threads and buttonholes.

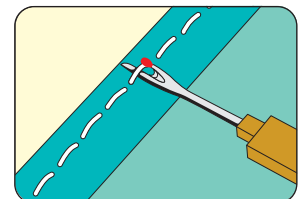

# Marking Tools

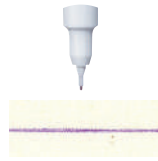

<Extra Fine>  
 Markings naturally disappear in 2 - 7 days.

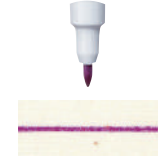

<Thick>  
 Markings naturally disappear in 4 - 14 days.

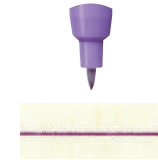

<Fine>  
 Markings naturally disappear in 4 - 14 days.

**5030**  
**Air Erasable Marker (Purple Extra Fine)**

**5031**  
**Air Erasable Marker (Purple Thick)**

**5032**  
**Air Erasable Marker with Eraser (Purple Fine)**

1 pc./pack	3 packs/box
Package Size	8.25 x 1.75 x 0.5 in



**515**  
**Water Erasable Marker (Fine)**

1 pc./pack	3 packs/box
Package Size	7.5 x 1.62 x 0.5 in

**516**  
**Water Erasable Marker (Thick)**

1 pc./pack	3 packs/box
Package Size	7.5 x 1.62 x 0.5 in

Markings can be quickly removed with water.

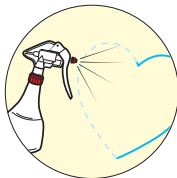

**5012**  
**Chacopen Pink with Eraser (Air Erasable)**

1 pc./pack	3 packs/box
Package Size	7.5 x 1.62 x 0.5 in

Markings will fade out over time (within 2-10 days).  
 Comes with a convenient "Eraser Pen" for immediate erasure of unwanted marks.



**5013**  
**Chacopen Blue with Eraser (Water Erasable)**

1 pc./pack	3 packs/box
Package Size	7.5 x 1.62 x 0.5 in

Water Erasable.  
 Comes with a convenient "ERASER PEN" for immediate erasure of unwanted marks.

## White Marking Pen



**517**  
**White Marking Pen (Fine)**

1 pc./pack	3 packs/box
Package Size	8.25 x 1.62 x 0.5 in

A white marker perfect for marking black and dark-coloured fabrics. Markings disappear when washed or ironed.



**518**  
**Eraser Pen**

1 pc./pack	3 packs/box
Package Size	7.5 x 1.62 x 0.5 in

Used to remove markings made by Water Erasable Markers.

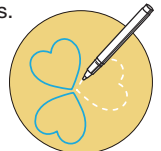

# Marking Tools



**5003**  
Water Soluble Pencil  
(Package of 3)



3 pcs./pack	3 packs/box
Package Size	10 x 1.75 x 0.5 in

**5000**  
Water Soluble Pencil  
(White)



**5001**  
Water Soluble Pencil  
(Blue)



**5002**  
Water Soluble Pencil  
(Pink)



1 pc./pack	3 packs/box
Package Size	10 x 1.75 x 0.5 in

The Water Soluble Pencils can be easily wiped off with water.  
Best suited for precise marking on fabric.



**418**  
Chacopel Fine



1 set/pack	3 packs/box
Package Size	10 x 1.75 x 0.5 in

Fine lines can be clearly marked.

**Contents**

- White: 1 pc.
- Yellow: 1 pc.
- Pink/Blue: 1 pc.
- Sharpener: 1 pc.

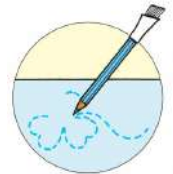

**5004**  
Iron-On Transfer Pencil  
(Red)



**5005**  
Iron-On Transfer Pencil  
(Blue)



1 pc./pack	3 packs/box
Package Size	10 x 1.75 x 0.5 in

Draw designs with the Iron-On Transfer Pencil, and transfer it onto the fabric with an iron.

The traced design can be transferred to fabrics, papers and woodblocks.



For transferring the appliqué and doll designs.



Easy transfer with an iron.  
The traced design can be used for 2-3 times.

**How to use:**

- (1) Place tracing paper on the design that you wish to transfer.
- (2) Trace the design with the Iron-On Transfer Pencil.
- (3) Place the traced design on the fabric and iron.  
The traced design will appear on the fabric.



# Marking Tools

A powder chalk which allows you to mark fabric as if you are drawing with a pen

A powder-based chalk for drawing thin, beautiful lines. With its pen-like use, you can make marks as if you are drawing freehand.

## Features of Chaco Liner Pen Style

*Length, thickness and angle that are easy to hold*

The length and thickness have been designed to achieve the pen-like ease-of-use.

Also, the chalk can be easily turned around to draw both straight and curved lines freely as it supports many different angles.

*Marks can be easily made along the ruler*

You can draw beautiful lines along the ruler with the pointed tip.

*The amount of remaining powder is visible*

You can see how much powder you have left through the transparent case.

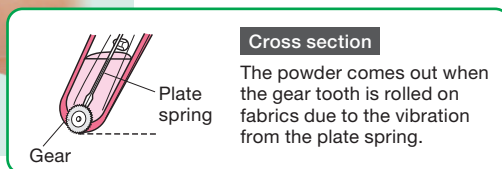

*Save time on refilling by exchanging the cartridge*

Powder can be refilled easily by simply exchanging the cartridge. When refilling, the powder will hardly spill over or dirty your hand.



*Smooth touch*

The shape of the sharp gear tooth, inner parts and powder components were carefully reviewed to achieve a smooth touch.



NET: 2.5 g approx.



**4710**  
Chaco Liner Pen Style (Blue)

**4711**  
Chaco Liner Pen Style (Pink)

**4712**  
Chaco Liner Pen Style (White)

**4713**  
Chaco Liner Pen Style (Yellow)

**4714**  
Chaco Liner Pen Style (Silver)

1 pc./pack	3 packs/box
Package Size	7.5 x 2.5 x 0.6 in

Wheel tip powder chalk. Permits accurate markings for both straight lines and freehand curves.

## Refills for Chaco Liner Pen Styles.



NET: 2.5 g approx.

*Easy Replacement*



**4720**  
Refill Cartridge for Chaco Liner Pen Style (Blue)

**4721**  
Refill Cartridge for Chaco Liner Pen Style (Pink)

**4722**  
Refill Cartridge for Chaco Liner Pen Style (White)

**4723**  
Refill Cartridge for Chaco Liner Pen Style (Yellow)

**4724**  
Refill Cartridge for Chaco Liner Pen Style (Silver)

1 pc./pack	3 packs/box
Package Size	7.5 x 2.5 x 0.6 in



# Marking Tools

Powder chalk.  
Chaco Liners are perfect for drawing thin lines.  
Wheel tip for accurate marking on fabric.



**469/B**  
**Chaco Liner (Blue)**

0 51221 51471 5

**469/P**  
**Chaco Liner (Pink)**

0 51221 51470 8

**469/W**  
**Chaco Liner (White)**

0 51221 51472 2

**469/Y**  
**Chaco Liner (Yellow)**

0 51221 51469 2

1 pc./pack	3 packs/box
Package Size	6.13 x 3 x 0.75 in



NET: 2.2 g approx.



## Powder chalk refills for Chaco Liners.



NET (1 pc.): 2.8 g approx.

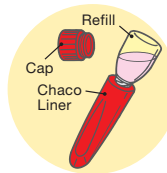

**470/B**  
**Chaco Liner Refill (Blue)**

0 51221 51481 4

**470/P**  
**Chaco Liner Refill (Pink)**

0 51221 51480 7

**470/W**  
**Chaco Liner Refill (White)**

0 51221 51482 1

**470/Y**  
**Chaco Liner Refill (Yellow)**

0 51221 51483 8

2 pcs./pack	3 packs/box
Package Size	4.13 x 2.63 x 1 in

## Tailor's Chalks available in four colors.



Size: 30 x 25 cm

**434**  
**Tracing Paper "Clover Chacopy"**

0 51221 51343 5

5 sheets/pack	3 packs/box
Package Size	13 x 5.25 x x 0.25 in

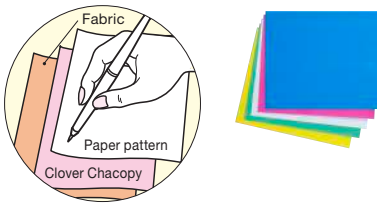

**432/B**  
**Triangle Tailor's Chalk (Blue)**

0 51221 51215 5

**432/W**  
**Triangle Tailor's Chalk (White)**

0 51221 51217 9

**432/Y**  
**Triangle Tailor's Chalk (Yellow)**

0 51221 51218 6

**432/R**  
**Triangle Tailor's Chalk (Red)**

0 51221 51216 2

1 pc./pack	3 packs/box
Package Size	3.25 x 2 x 0.38 in



432/B      432/W      432/Y      432/R

# Marking Tools

## Marking tool use and method of erasure

★Make sure to always test the tools (by marking and erasing) on an edge of the cloth before use.

◎=optimal / ○=suitable/△=usable

Art No.		5030, 5031, 5032	515, 516, 5013	517	418	5000, 5001, 5002, 5003
Product image						
Usage	Sewing	◎	◎	◎	◎	◎
	Patchwork	○	○	○	○	○
	Embroidery	○	○	○		○
Method of erasure	Disappears over time	◎ 4 to 14days*				
	Spray with water	◎	◎			○
	Wash with water	◎	◎	◎	△	◎
	Use an erasing pen	◎	◎			
	Heat from an iron			◎		
	Use a brush				△	
Remarks		- Pen type - For white and light-colored fabric * Art No. 5030 markings will disappear in about 2 to 7 days.	- Pen type - For white and light-colored fabric	- Pen type - For black and dark-colored fabric	- Pencil type	- Pencil type - A soft lead makes it is easy to apply - Can also be used on felt

Art No.		4710, 4711, 4712, 4713, 4714	469/B, 469/P, 469/W, 469/Y	432/B, 432/W, 432/Y, 432/R	434	5004, 5005
Product image						
Usage	Sewing	◎	◎	◎	◎	Applique, stuffed animals
	Patchwork					
	Embroidery				○	
Method of erasure	Disappears over time			Does not disappear		Does not disappear
	Spray with water					
	Wash with water	△	△		◎	
	Use an erasing pen					
	Heat from an iron					
	Use a brush	△	△			
Remarks		- Powder type - Avoid heat sources such as ironing	- Powder type - Avoid heat sources such as ironing	- Avoid heat sources such as ironing		- Pencil type - For white and light-colored fabric





# Silk Threads

<b>701</b>	
<b>Silk Threads</b>	
Description	36 colors available 100% Silk Thread 109 yards Size No. 50
Packing	6 spools/box
Package Size	6.25 x 1.25 x 1.12 in

	<b>701/401</b> White
	
0 51221 51000 7	

	<b>701/403</b> Winter White
	
0 51221 51002 1	

	<b>701/041</b> Linen
	
0 51221 51021 2	

	<b>701/042</b> Egg Shell
	
0 51221 51022 9	

	<b>701/205</b> Gray
	
0 51221 51071 7	

	<b>701/051</b> Blue Gray
	
0 51221 51026 7	

	<b>701/021</b> Steel
	
0 51221 51009 0	

	<b>701/039</b> Taupe
	
0 51221 51020 5	

	<b>701/120</b> Lead
	
0 51221 51050 2	

	<b>701/402</b> Black
	
0 51221 51001 4	

	<b>701/009</b> French Navy
	
0 51221 51004 5	

	<b>701/107</b> Colonial Blue
	
0 51221 51044 1	

	<b>701/052</b> Light Aqua
	
0 51221 51027 4	

	<b>701/118</b> Holly Green
	
0 51221 51049 6	

	<b>701/035</b> Emerald
	
0 51221 51016 8	

	<b>701/084</b> Churchill Green
	
0 51221 51038 0	

	<b>701/095</b> Seaweed
	
0 51221 51040 3	

	<b>701/096</b> Chartreuse
	
0 51221 51041 0	

	<b>701/057</b> Purple
	
0 51221 51031 1	

	<b>701/129</b> Grape
	
0 51221 51052 6	

	<b>701/053</b> Amethyst
	
0 51221 51028 1	

	<b>701/005</b> Lilac
	
0 51221 51003 8	

	<b>701/143</b> Magenta
	
0 51221 51060 1	

	<b>701/030</b> Medium Pink
	
0 51221 51014 4	

	<b>701/014</b> Light Pink
	
0 51221 51007 6	

	<b>701/064</b> Maroon
	
0 51221 51033 5	

	<b>701/038</b> Aubergine
	
0 51221 51019 9	

	<b>701/155</b> Red
	
0 51221 51068 7	

	<b>701/010</b> Cherry
	
0 51221 51005 2	

	<b>701/011</b> Cranberry
	
0 51221 51006 9	

	<b>701/061</b> Shrimp
	
0 51221 51032 8	

	<b>701/029</b> Golden Rod
	
0 51221 51013 7	

	<b>701/075</b> Light Gold
	
0 51221 51035 9	

	<b>701/074</b> Harvest Gold
	
0 51221 51034 2	

	<b>701/043</b> Beige
	
0 51221 51023 6	

	<b>701/117</b> Dark Brown
	
0 51221 51048 9	

# Sewing & Patchwork Accessories

**For more efficient craftwork!**

Amazing pressing force with just a little effort!

The Roll & Press is a quick and efficient way to make creases or to open and fold seam allowances.

Quick, portable, ergonomic.



7812	
Roll & Press	
1 pc./pack	3 packs/box
Package Size	8.27 x 3.15 x 1.18 in

Roll to press a seam or fold, either straight, curved or paper pieced seams.

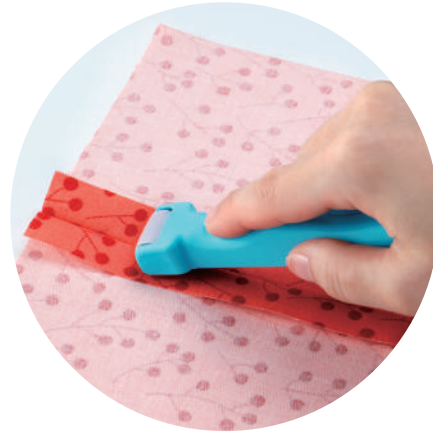

**Convenient in these situations too!**

- For laminates and other fabrics that cannot be ironed
- For foundation piecing (paper piecing) and machine piecing
- For making a crease before ironing

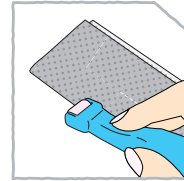

• Crease fabric

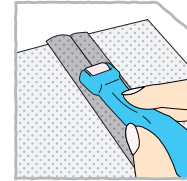

• Fold seam allowance  
• Open seam allowance

**Fabric and hand-friendly.**

**A roller that glides smoothly**

- Doesn't pull or distort fabric
- Allows you to press fabrics along straight or curved lines

**Quick, portable, ergonomic**

- Can be held in most comfortable position - left or right handed
- Just a little downward force is all that is needed for significant pressing action.

**Press small areas with accuracy**

- The roller's slight arc allows you to focus pressure on precise areas
- Roller edges will not leave creases on the fabric

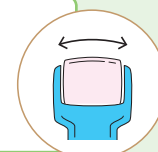

# Sewing & Patchwork Accessories

Suitable for making creases and opening and folding the seam allowance of a piece.



495 <b>Finger Presser</b>	
1 pc./pack	3 packs/box
Package Size	7.5 x 1.75 x 0.5 in

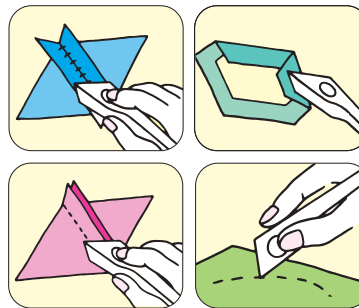

Perfect for foundation piecing, patchwork and appliqué. Made from abrasion-resistant durable material.

The ideal shape of the spatula and the extra thin tip useful in folding are perfect for appliqué.



4002 <b>"HERA"™ Marker for Appliqué &amp; Sewing</b>	
1 pc./pack	3 packs/box
Package Size	8.25 x 1.38 x 0.38 in

Usage examples of the spatula

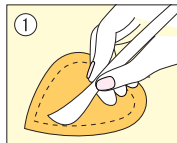

This marker is easy to use for appliqué work and creasing.

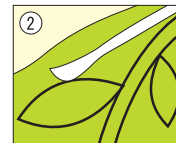

For making marks on appliqué and reverse appliqué



Extra thin tip with curved design.

Usage example of the sharp tip

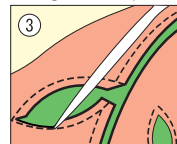

For folding appliqué and reverse appliqué

Used for marking and creasing on fabric.



490/NV <b>"HERA"™ Marker</b>	
1 pc./pack	3 packs/box
Package Size	7.5 x 1.75 x 0.38 in



An easy grip, easy press spatula



4053 <b>Fabric Folding Pen</b>	
2 pc./pack	3 packs/box
Package Size	2 x 5.5 x 0.25 in



4054 <b>Fabric Folding Pen Liquid</b>	
1 pc./pack	3 packs/box
Package Size	2 x 4 x 0.25 in

Fabric Folding Pen Liquid for Fabric Folding Pen (Art. No. 4053). Bottle holds 8 ml of solution.



# Sewing & Patchwork Accessories

**A sewing ruler with adequate flexibility.**

This ruler is perfect for sewing/knitting drafts or drawing seam lines.

Parallel lines can be drawn accurately at several distances.

The ruler is made of a flexible material to help measure curved portions.

With this ruler, you can clearly read scales even on dark-coloured fabrics and easily draw a true bias line with a 45° line.

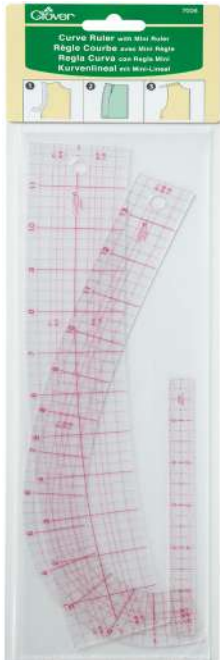

**7006**  
**Curve Ruler with Mini Ruler**

1 set/pack	3 packs/box
Package Size	15.5 x 4.3 x .12 in

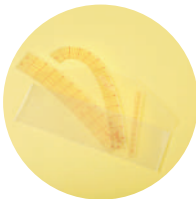

The rulers come with a case.

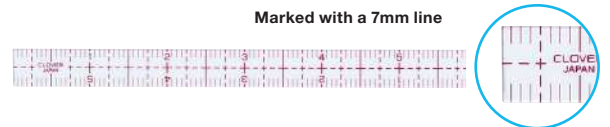
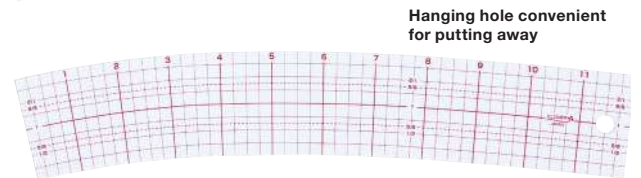
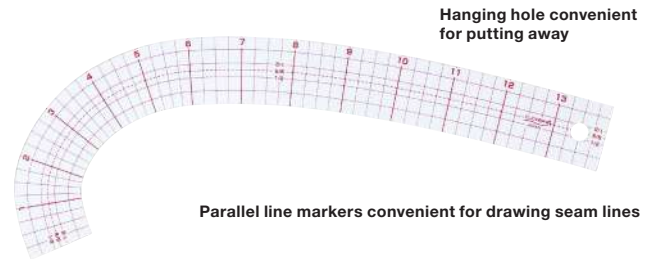

**Curves perfect for sewing**

Deep curve  
 For the neckline or armhole



Gentle curves  
 For the hem and hip lines



Mini ruler (15 cm)  
 For measuring intricate portions

**The compact, easy-to-use curve ruler with parallel lines useful for marking seam allowances.**

These rulers are optimal for drawing curved lines when copying sewing patterns, creating drafts, or drawing curved seam lines quickly and neatly.

Parallel lines are marked along the edge of the curve, enabling the drawing of curved seam lines easily.

This is a set of two curve rulers and a mini ruler (15cm).

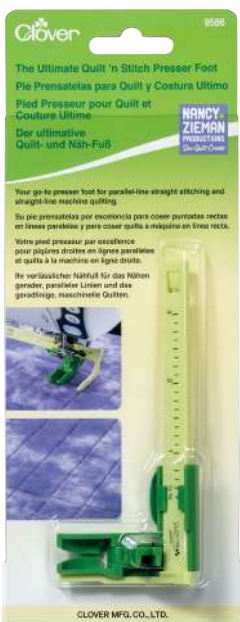

**9586**  
**The Ultimate Quilt 'n Stitch Presser Foot with NANCY ZIEMAN®**

1 set/pack	3 packs/box
Package Size	6.69 x 1.97 x 0.06 in

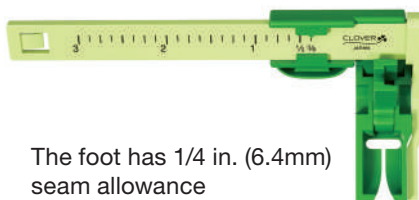

Move the ruler to set distance between needle and alignment guide 3/8" (9.5mm) to 3" (76.2mm).

Your go-to Presser foot for parallel-line stitching and straight line machine quilting. Presser foot with built-in alignment ruler for guiding rows of parallel stitching. Easily stitch multiple rows without marking everyline.





# Sewing & Patchwork Accessories

This sliding gauge is useful in marking seam allowances.  
 Multipurpose sliding gauge useful for marking.



**9506**  
**5-in-1 Sliding Gauge**  
 with NANCYZIEMAN®

1 pc./pack	3 packs/box
Package Size	9 x 4.12 x 0.5 in

Convenient for drawing seam lines, hem lines, tucks, pleats, buttonholes and other markers where the same dimensions need to be used repeatedly.



A multifunctional 11 inch (279.4 mm) sliding gauge for easy marking!

Create 1/2 - square or 1/4 - square triangle blocks without ever cutting triangles.



**9585**  
**Supersize 5-in-1 Sliding Gauge**  
 with NANCYZIEMAN®

1 pc./pack	3 packs/box
Package Size	14.76 x 4.53 x 0.39 in



**9579**  
**No-Hassle Triangles Gauge**  
 with NANCYZIEMAN®

1 pc./pack	3 packs/box
Package Size	14.62 x 3.87 x 0.62 in

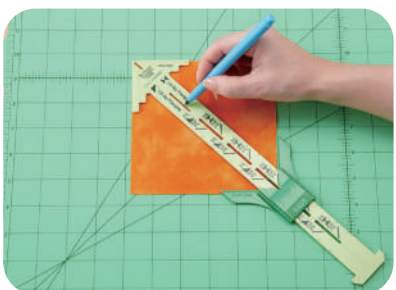



# Sewing & Patchwork Accessories

This ruler can simplify three-folding, hemming and cloth wrapping.

Fold, measure, press hems and more in one step.



<b>7806</b>	
<b>Hot Hemmer</b>	
	
1 pc./pack	3 packs/box
Package Size 6 x 5.5 x 0.5 in	

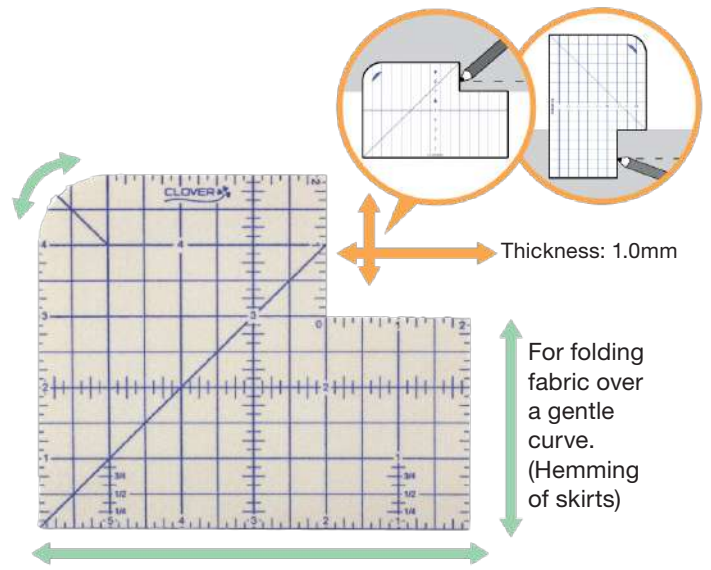
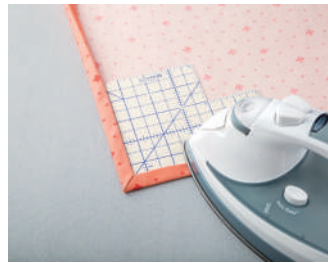

For folding fabric over a long straight line.  
(Hemming of shirts, pants, and more)

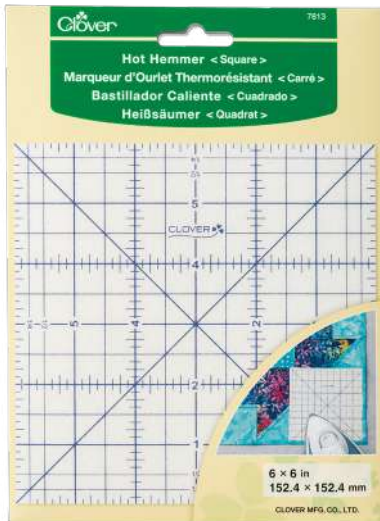

<b>7813</b>	
<b>Hot Hemmer &lt;Square&gt;</b>	
	
1 pc./pack	3 packs/box
Package Size 8.6 x 6.3 x 0.12 in	

Great for pressing all sizes of Dresden wedges, under edges of quilt block appliqué, and geometric appliqué for quilting.

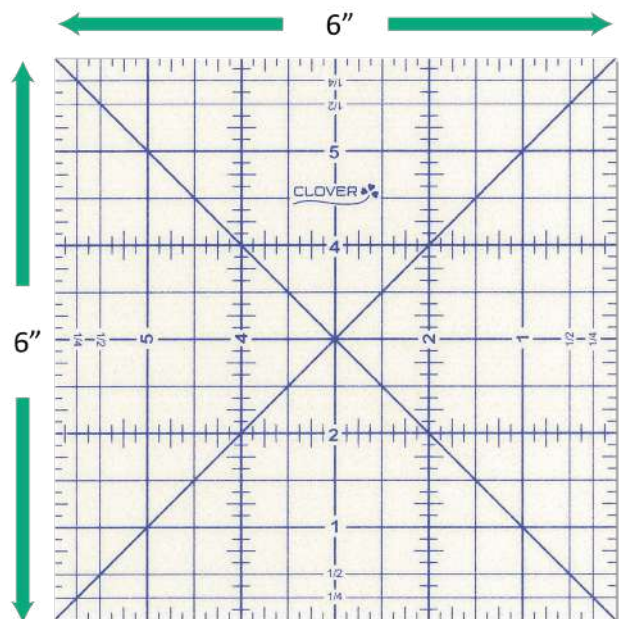
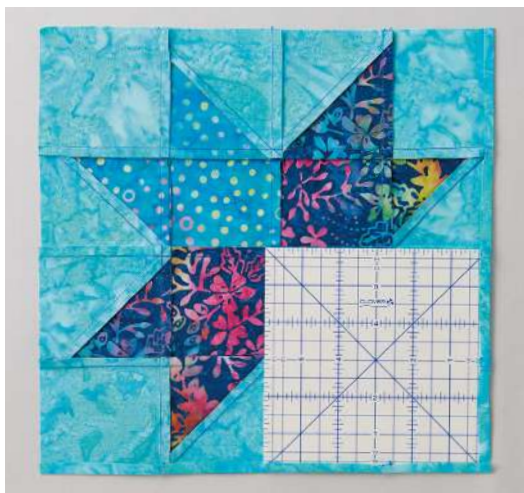



# Sewing & Patchwork Accessories

Convenient for folding fabric over a long straight line or a curve

This long version of the Clover Hot Hemmer can simplify three-folding, hemming and cloth wrapping. Measure, mark, fold, press: deep hems, long hems.



**7811**  
**Hot Ruler**



0 51221 77811 7

1 pc./pack	3 packs/box
Package Size	12 x 4 x 0.12 in

Thickness: 1.0mm  
For long straight lines!  
10 in. long



**7814**  
**Hot Ruler <Large>**



0 51221 77814 8

1 pc./pack	3 packs/box
Package Size	14.96 x 4.33 x 0.12 in

For extra long straight lines!  
14 in. long



Measure, mark, and press hems and more in one step. Great for deep hems, long hems and to miter corners.

Heat resistant, thin, accurate ruler can be pressed with dry/steam iron, features non-slip surface to hold fabric for precise results.

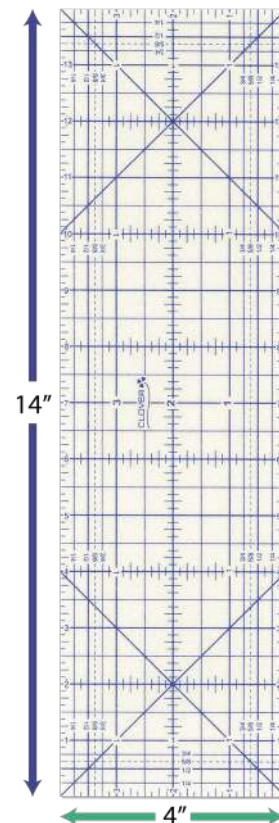
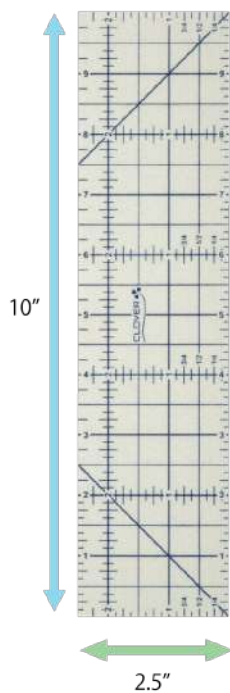



# Sewing & Patchwork Accessories

Thread both large-sized and small-sized needles easily and flawlessly.

You can easily thread needles of any size by inserting them into the same place and pressing a button. Most of Clover Needles (0.51-0.89mm) for sewing and patchwork can be threaded.

Choose Clover Needles for smooth threading!



4071	
Desk Needle Threader (Purple)	
1 pc./pack	3 packs/box
Package Size	5.75 x 4.37 x 1.12 in

4072	
Desk Needle Threader (Green)	
1 pc./pack	3 packs/box
Package Size	5.75 x 4.37 x 1.12 in

4073	
Desk Needle Threader (Pink)	
1 pc./pack	3 packs/box
Package Size	5.75 x 4.37 x 1.12 in

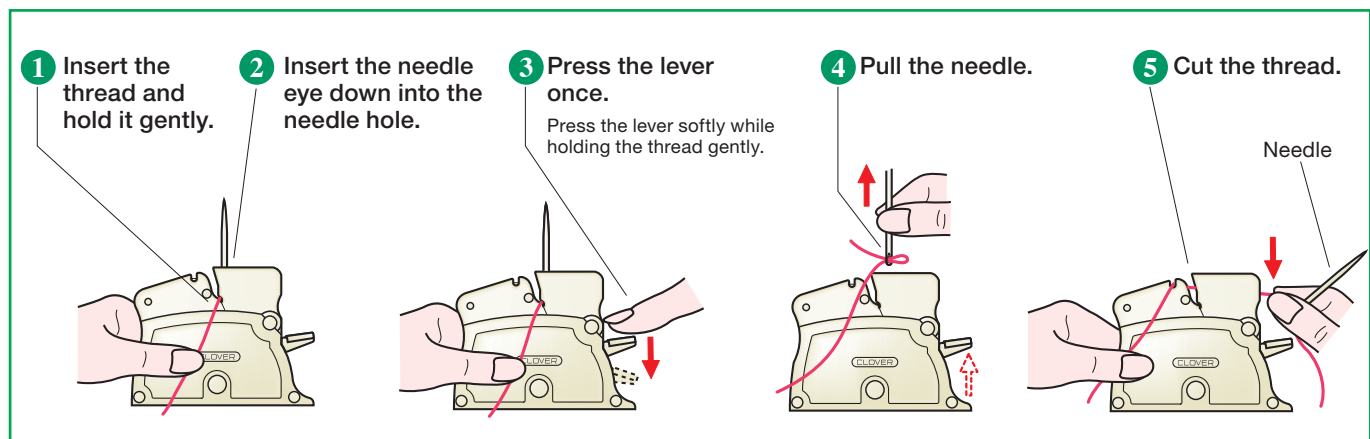

Caution: If the thread does not go through, place the needle down and repeat the procedures ① to ④.

<Cautions for use>

- Make sure the thread thickness is applicable to the size of the needle.
- When the thread is pushed through the eye of the needle with too much force, it may be damaged. In this case, pull thread through the eye and cut off the damaged part.
- To store this product, remove needle.

# Sewing & Patchwork Accessories



**478**  
**Threader with Cutter "PETIT CUT"**

2 pcs./pack	3 packs/box
Package Size	4.12 x 2.62 x 0.12 in

Threader and cutter in one.

How to use:

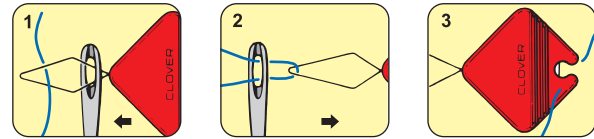

**466**  
**Quilt Needle Threader**

1 pc./pack	3 packs/box
Package Size	4.12 x 2.62 x 0.25 in

Antique gold Quilt Needle Threader used for threading fine needles.

How to use:

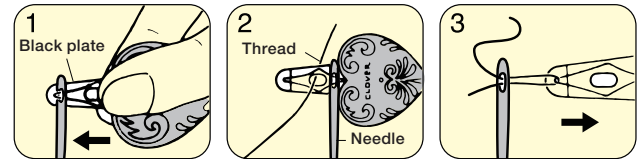

- (1) Insert the wire on the black plate into the needle eye.
- (2) Insert the thread through the wire and the hole in the black plate.
- (3) Pull the needle off the wire.

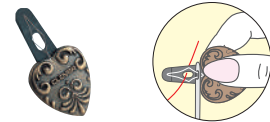

**462/NV**  
**Double Needle Threader**

1 pc./pack	3 packs/box
Package Size	6 x 1.62 x 0.25 in

Thread both large-sized and small-sized needles.

How to use:

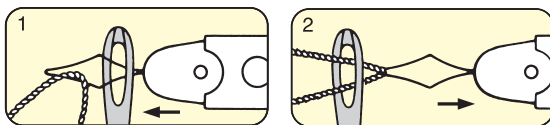

**4000**  
**Threader**

2 pc./pack	36 packs/box
Package Size	4.12 x 2 x 0.06 in



## Eye-catching design with new functions.

*Threader specially designed for embroidery threads (embroidery needles).*



**8611**  
**Embroidery Threader**

1 pc./pack	3 packs/box
Package Size	5.87 x 2.12 x 0.37 in

Comes with a cap



Embroidery Threader has a "Flat tip" for easy and smooth threading even with thick threads.

Thread even thick threads smoothly

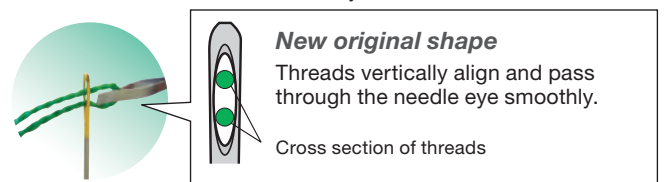

**New original shape**  
 Threads vertically align and pass through the needle eye smoothly.  
 Cross section of threads

\*Please use the designated number and types of threads for each embroidery needle.

# Sewing & Patchwork Accessories

## "Quick Cut" Thread Cutter

The "Quick Cut" Thread Cutter allows you to quickly and easily separate your quilt chain pieces.



7490	
"Quick Cut" Thread Cutter	

1 pc./pack	3 packs/box
Package Size	5.5 x 2.36 x 1.5 in



You can move the blade 12 positions to get a new blade edge.



Our unique design protects your fingers when you set and cut the thread.

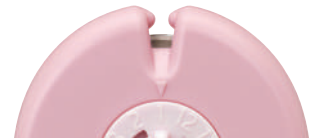

\* It features Clover's 45mm Rotary Cutter blade which can be replaced.



415	
Thread Clipper "KUROHA"	

1 pc./pack	3 packs/box
Package Size	7.25 x 3.37 x 0.5 in

High quality precision clipper with excellent sharp cutting edge.

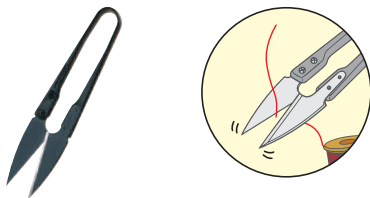

522	
Thread Tweezer	

1 pc./pack	5 packs/box
Package Size	7.25 x 3 x 0.5 in



454	
Thread Cutter Pendant (Antique Silver)	

455	
Thread Cutter Pendant (Antique Gold)	

1 pc./pack	3 packs/box
Package Size	4.13 x 2.5 x 0.4 in



The thread cutter pendant has a built-in sharp circular blade to cut threads. It can be set on top of a thread wheel or used as a pendant. Available in antique silver & antique gold.







# Sewing & Patchwork Accessories

You can store threaded needles by winding them onto the reel.

How to use:  
(1) Insert the threaded needle into the groove.



**625**  
**Dome Threaded Needle Case**

1 pc./pack	3 packs/box
Package Size	6.5 x 3.87 x 1.12 in

Store 10 threaded needles neatly!

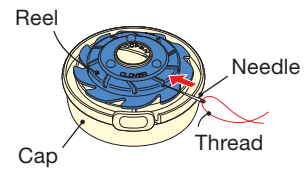

(2) Rotate dome to wind the thread.

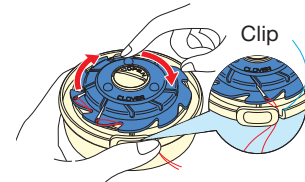

(3) To remove the needle, hold the dome and pull the needle slowly.

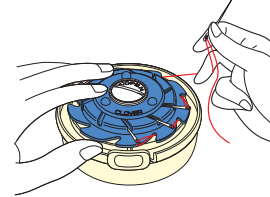

**9575**  
**Pin 'n Stow**  
with NANCYZIEMAN®

1 pc./pack	3 packs/box
Package Size	8.5 x 2.25 x 0.75 in

- Its magnetic!
- Band fits to wrist with a "Slap".
- Grooved for easy pickup.



## Magnet Pin Caddy

Drop needles on the Magnet Pin Caddy and it will catch and store them in the same direction with its magnetic force.



**4105**  
**Magnet Pin Caddy**  
(Bordeaux)

1 pc./pack	3 packs/box
Package Size	8.62 x 5.87 x 0.75 in

Center groove makes picking up pins from caddy easy. Includes cover for safe and easy storage, and allows for stacking caddy. Multiple cushions can be stacked for storage.



The Magnet Pin Caddy comes with fine and smooth Clover Silk Pins (10 pins) for trial.





# Sewing & Patchwork Accessories

## Sweet 'n Sharp Macaron

Cute magnetic needle holder & Needle sharpener.

- Catch needles on magnetic surface.
- Polish needles with cream filled cushion.
- Needles sharpened regularly penetrate smoothly the fabric.



### How to polish needles

1. Insert the needle slowly into the central filling cushion part.



2. Hold the upper and lower sides of the macaron.

3. While checking the polishing condition, insert and pull out the needle several times.

<b>4130</b> <b>Sweet 'n Sharp Macaron (Raspberry)</b>		<b>4131</b> <b>Sweet 'n Sharp Macaron (Pistachio)</b>	
1 pc./pack	3 packs/box	1 pc./pack	3 packs/box
Package Size	4.72 x 2.36 x .91 in	Package Size	4.72 x 2.36 x .91 in



<b>9582</b> <b>Clip 'n Glide Bodkin</b>	
1 pc./pack	3 packs/box
Package Size	9 x 3 x 0.25 in

- Clip provides firm hold on elastic end for pulling through casing with ease.  
Suitable elastic width: 5/8 in. (15 mm) or wider  
Width of casing opening: 3/4 in. (20 mm) or wider
- Exceptional flexibility ensures smooth passage along curvy areas.



<b>9581</b> <b>Flex 'n Glide Bodkin with NANCYZIEMAN®</b>	
1 pc./pack	3 packs/box
Package Size	9 x 3 x 0.25 in

- Handy length and flexibility allow smooth passage even along curves.
- Flex 'n Gilde Bodkin eye features grippers to ensure drawstring remains firmly in place.
- Large bodkin eye is ideal for easy threading of wide or narrow drawstring.



<b>4001</b> <b>Bodkin (2 Types)</b>	
2 pcs./pack	3 packs/box
Package Size	5 x 2 x 0.25 in

For threading of ribbon and elastic tape.

Slide to lock.

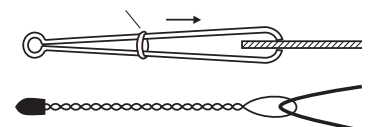

# Sewing & Patchwork Accessories

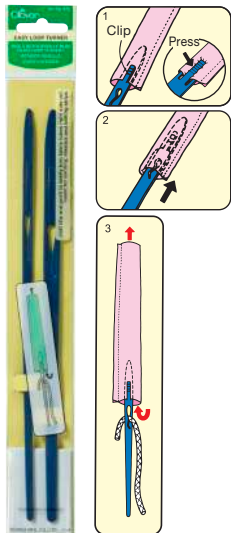

**472**  
**Easy Loop Turner**

2 pcs. (2 sizes)/pack	3 packs/box
Package Size	13 x 1.75 x 0.13 in



For turning loops inside out.  
The loop can be used to insert cording by tying it to the hole.  
(See illustration 3.)



**4910**  
**Soft Touch Thread Pick**

1 pc./pack	3 packs/box
Package Size	7.5 x 1.5 x 0.5 in

- The perfect tool for hiding or removing stray threads
- Easily slips through the top fabric, leaving no marks or punctures
- Ideal for long-arm quilters and machine embroidery

Steel tip



Optimal shape for grabbing thread!



**4052**  
**Loop Pressing Bars**

5 pcs. (5 sizes)/pack	3 packs/box
Package Size	13 x 4 x 0.25 in

Easily make loops, 3D appliqué and Celtic designs.  
Seam allowance can be pressed with iron.  
The loop can be used to insert cording by tying it to the hole.

Available widths:  
6, 9, 12, 15, 18 mm



**4095**  
**Design Pro Appliqué Mat**

1 pc./pack	3 packs/box
Package Size	13 x 2.5 x 2 in

- Non-slip surface texture holds appliqué pieces in place.
- Transparent mat ensures precision placement.
- Non-stick surface texture allows repeated use of fusible materials.

Contents:  
Appliqué mat: 1  
Pressing sheet: 1

Instructions for appliqué:



Trim fused fabric into desired shapes.

Place design under mat and assemble fused pieces.

Press pieces in place using pressing sheet.



Remove appliqué from the mat.



Place the appliqué on base fabric and press.



**474**  
**Mesh Transfer Canvas**

1 pc./pack	3 packs/box
Package Size	15 x 2.75 x 1 in

The sheet of fine mesh is useful for transferring quilt lines and appliqué design layouts.  
By using the mesh you don't have to cut out the shape you want to use and trace around.

12 x 16 in

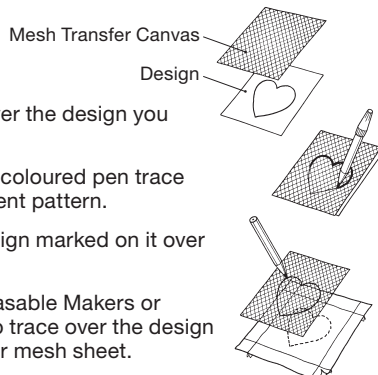

How to use:

- (1) Place the mesh sheet over the design you wish to use.
- (2) Using a ballpoint pen or coloured pen trace the design for a permanent pattern.
- (3) Place the mesh with design marked on it over your fabric.
- (4) Using Clover's Water Erasable Makers or Chacopel Fine pencils to trace over the design you have marked on your mesh sheet.



**9505**  
**Double Sided Basting Tape**

1 pc./pack	3 packs/box
Package Size	5 x 3.75 x 0.5 in

Quickly and easily adheres to fabric, paper or wood.

Size: 12 mm x 1/2 in



# Sewing & Patchwork Accessories



**4120**  
**Create-a-Pincushion (Brown)**

3 pcs./pack	3 packs/box
Package Size	2.5 x 5 x 1 in



Create your own personalized pincushion.



**806**  
**Spring Tape Measure (60 inch/150 cm)**

1 pc./pack	3 packs/box
Package Size	6.12 x 3 x 0.75 in

Fiber glass tape measure prevents from stretching. Inches and metric measurement.

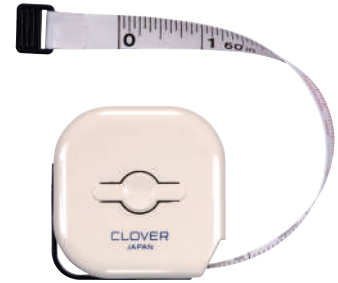

## QUICK BIAS <Fusible Bias Tape>

Easily ironed on to straight or curved fabric designs. It will eliminate time consumed in making and pinning it in place. Excellent for use in Stained Glass Quilting, Celtic and Appliqué work or projects.

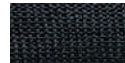

**700/BLK**  
**QUICK BIAS <Fusible Bias Tape> (Black)**



**700/GOLD**  
**QUICK BIAS <Fusible Bias Tape> (Gold)**



**700/SILVER**  
**QUICK BIAS <Fusible Bias Tape> (Silver)**

Width:6mm

1 pc./pack	6 packs/box
Package Size	10.5 x 8.8 x 0.8 cm

\* Actual colours may vary from printed version.



**800/BLK**  
**Quick Bias 100 Yards (91 m)**

1 set./pack	3 packs/box
Package Size	9.75 inches diameter



# Sewing & Patchwork Accessories



7803	
Point 2 Point Turner	
	
1 pc./pack	3 packs/box
Package Size	9 x 2.75 x 0.35 in



**Turn every point perfectly.**

- Curved end with tip for point turning.
- Fine tipped end for detail work.
- Designed to be comfortable and secure in hand when using either end.



7807	
Hold It Precision Stiletto	
	
1 pc./pack	3 packs/box
Package Size	6 x 2.5 x 1 in

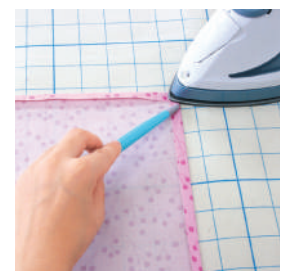
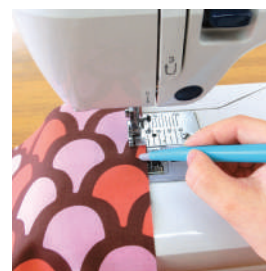

**Hold while sewing or pressing.**

- Grippy tip for holding fabric.
- Angled tip for good reach and visibility.
- Heat resistant silicone tip for working near iron while pressing.

## Wonder Fuse



4091	
Wonder Fuse (18 in x 3 yd roll)	
	
1 roll/pack	3 packs/box
Package Size	19.7 x 2.44 x 2.44 in

- Lightweight, fusible web.
- Useful for applique on apparel, quilts, embroidery, and more.



4090	
Wonder Fuse (9 x 8 in sheets)	
	
10 pcs/pack	3 packs/box
Package Size	10.62 x 4.75 x .62 in

- Lightweight, fusible web.
- Useful for applique on apparel, quilts, embroidery, and more.

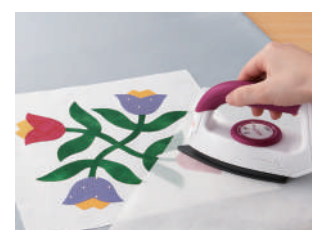



# Sewing & Patchwork Accessories

A stitch guide that can be aligned with the edge of the fabric for stitching.



9584	
Stitch Guide	
1 set/pack	3 packs/box
Package Size	7 x 3.7 x .47 in



**Comes with a position-adjusting plate!**

Now the plate can be kept parallel and the guide can be positioned more easily with a hole for a sewing-machine needle.

The needle goes into the hole.

Stitch guide

Position-adjusting plate

**Note:**  
This guide is suitable for sewing machines of which gap between a needle clamp screw and a needle plate is higher than 8mm.

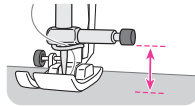

If the stitch guide is aligned with the fabric before stitching with a sewing machine, a neat stitch with a consistent seam-width can be achieved.

The guide comes with an adhesive sheet that can adhere to both metal and plastic surfaces, enabling it to be fixed at any location.

When sewing curved seams

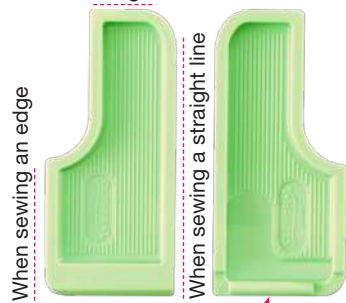

Two guides can be connected and used together

**Stitching straight**



Use the long side of the guide.



Use both guides connected.

**Stitching curves: use the short side of the guide.**



inner curve



outer curve

**Topstitching: place the guide in front of the presser foot and sew.**



**Stitching strips: with two guides, you can sew strips neatly.**



Sandwich with the two stitch guides



9508	
Stack 'n Store Bobbin Tower	
1 set/pack	3 packs/box
Package Size	4.5 x 2.75 x 2.75 in

- Holds most type of bobbin.
- Secures thread ends - no more tangles!
- See thread colours at a glance!
- Convenient and compact!



# I Sew For Fun Product Line by Nancy Zieman

**i sew  
for fun**

by Nancy Zieman

Share a fun creative experience  
with young, enthusiastic sewists.



**9600**  
**Sew-Safe Presser Foot**

0 51221 79600 5

1 pc./pack	3 packs/box
Package Size	7 x 3.7 x 0.55 in

Needle shield deters fingers away from needle area. Center needle marking on foot. 1/4" (6.4mm) seam allowance. Snap-on easily to many machines. Plus low shank adapter included.



**9603**  
**Retractable Seam Ripper**

0 51221 79603 6

1 pc./pack	3 packs/box
Package Size	7.28 x 2.56 x 0.47 in

For cutting threads on seams. Use when closed for cutting threads.



**9601**  
**Seam Guide**

0 51221 79601 2

1 pc./pack	3 packs/box
Package Size	7 x 3.7 x 0.39 in

Sew accurate seams everytime! 5/16 in. (8mm) thick for easy fabric guiding. Handle grip for ease in attaching and removing. Ideal for straight stitching, curves and top-stitching. Reusable and repositionable adhesive guide underside. Washable adhesive.



**9605**  
**Hand-Sewing Needles**

0 51221 79605 0

1 pc./pack	3 packs/box
Package Size	7.28 x 2.76 x 0.39 in

Adjustable heart-shaped case included. Extra fine high-quality needle.

Includes:

- Milliners No. 5 for heavy weight fabrics
- Betweens No. 5 for normal fabrics
- Embroidery No. 3 for big stitch or embellishment



**9602**  
**Magnet Pin Caddy**

0 51221 79602 9

1 pc./pack	3 packs/box
Package Size	7.28 x 5.31 x 1.38 in

Gathers and stores pins safely. Easy pick-up with pins stored in one direction and center grooves. Cover for safe keeping.



**9610**  
**Spring Tape Measure**

0 51221 79606 7

1 pc./pack	3 packs/box
Package Size	6.5 x 3.15 x 0.71 in

Retractable with the push of a button. Non-stretch, reinforced fiber glass. 1/16" markings for accuracy. Measures 60" (150 cm)





# I Sew For Fun Product Line by Nancy Zieman



**9612**  
**Roll 'n Press**

1 pc./pack	3 packs/box
Package Size	9 x 3 x 0.25 in

Roll to press seam or fold. Quick, portable, ergonomic.



**9613**  
**Point 2 Point Turner**

1 pc./pack	3 packs/box
Package Size	6.5 x 3.15 x 0.71 in

Curved tip for point turning.

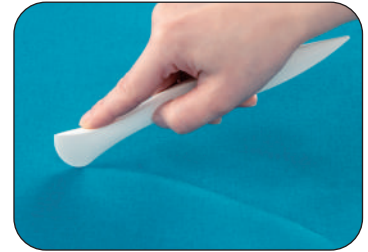

Fine tipped end for detail work.



**9614**  
**Protect 'n Grip Thimble**

1 pc./pack	3 packs/box
Package Size	9 x 3 x 0.25 in

Flexible fit keeps thimble in place. Metal tip for pushing needle.



**9615**  
**Flexible Rubber Thimble Set**

1 pc./pack	3 packs/box
Package Size	6.5 x 3.15 x 0.71 in

Index and thumb finger sheaths for ease in pulling through fabrics.

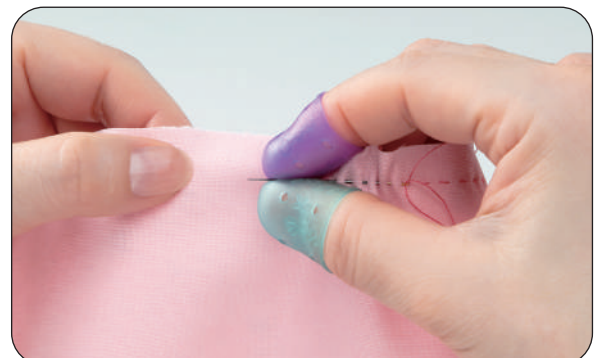

# Wonder Clips

All you have to do is clip it on and off

*Clips to temporarily hold fabric together for sewing <mini>*

Narrow tips for precision clipping

Maximum  
5/16 in

Small but  
opens wide!

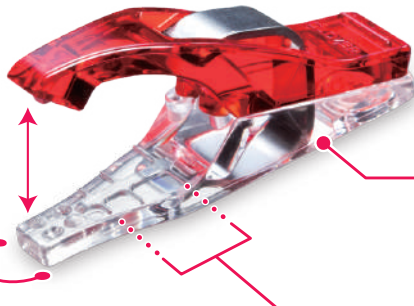

- Precision clipping.
- Small and light.
- Works well with sergers.
- As a marking for pieces of fabric.
- Comes with a 3/16 in, 1/4 in, & 3/8 in scale.

The back of the clip is flat, keeping the fabric down, for easy feeding into the presser foot

Narrow tip with 4  
projections to clip tightly!

A guide scale which can estimate seam allowances  
in units of 3/16, 1/4 and 3/8 in

When viewing  
from the back

Clips can be aligned  
with notch marks

3/16 in  
1/4 in  
3/8 in

When viewing  
from the front

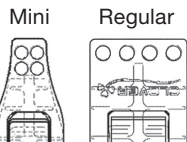

Though small, the Mini Wonder Clips have the same number of projections and clipping power as the regular Wonder Clips.

## Mini Wonder Clips

3188



3189



- Great alternative to pins, especially when working with vinyls, piles, and heavy weight fabrics.
- The small size works well with miniature patchwork, doll clothes, and all work that requires holding pieces together in tight sections.
- It is helpful when holding a curved line or for a short distance.
- Easy to see on your work and easy to find when dropped to the floor.

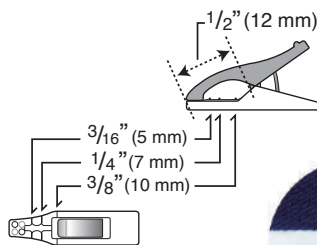

<b>3188</b>	
Mini Wonder Clips (20 pcs.)	
20 pcs./pack	3 packs/box
Package Size 7.5 x 3 x 0.5 in	

<b>3189</b>	
Mini Wonder Clips (Assortment/50 pcs.)	
50 pcs./pack	3 packs/box
Package Size 6 x 3 x 1.3 in	





# Wonder Clips

All you have to do is clip it on and off



## Wonder Clips

- Great alternative to pins, especially when working with vinyls, piles, and heavy weight fabrics.
- Holds layered sections of sewing projects such as, handle connectors to handbags, piping, etc. without distortion.
- Holds quilt binding while sewing.
- Easy to see on your work and easy to find when dropped to the floor.
- Works well with sergers.

Maximum  
1/3 in

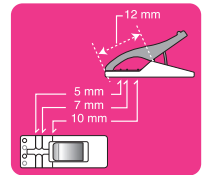
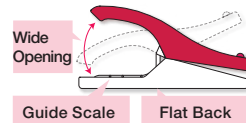

Seam allowance can be estimated in units of 3/16 in, 1/4 in, 3/8 in.



<b>3155</b>
<b>Wonder Clips (10 pcs.)</b>
0 51221 35615 5

<b>3180</b>
<b>Wonder Clips (Neon Green/10 pcs.)</b>
0 51221 73180 8

<b>3185</b>
<b>Wonder Clips (Assortment/10 pcs.)</b>
0 51221 73185 3

10 pcs./pack	3 packs/box
Package Size	7.25 x 3 x 0.5 in



3155/3156/3159

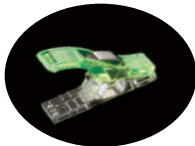

3180



3183/3185

Dressmaking requires many pins.



<b>3156</b>
<b>Wonder Clips (50 pcs.)</b>
0 51221 35616 2

<b>3183</b>
<b>Wonder Clips (Assortment/50 pcs.)</b>
0 51221 73183 9

50 pcs./pack	3 packs/box
Package Size	6 x 3 x 1.5 in



# Wonder Clips

Perfect for dressmaking which requires many pins to hold fabrics together.



3159	
Wonder Clips (100 pcs.)	
100 pcs./pack	3 packs/box
Package Size	8.5 x 4.75 x 2 in



## Jumbo Wonder Clips



3157	
Jumbo Wonder Clips (24 pcs.)	
24 pcs./pack	3 packs/box
Package Size	8.5 x 4.75 x 2 in

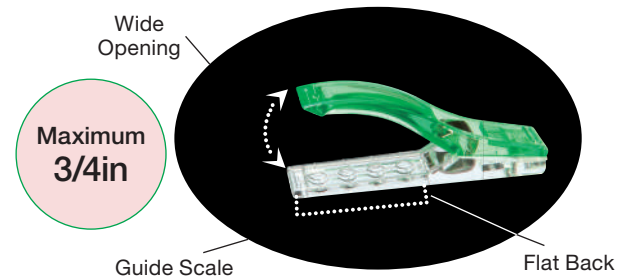
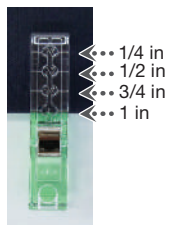

The clips are useful in holding laminated fabrics, synthetic leathers and other fabrics on which you do not wish to leave holes. The wide opening of the clips are also suitable for holding thick fabrics and zippers.

- Clip opens wide to hold layers of fabrics.
- Each clip can hold a length of up to 3cm.
- These clips are convenient for holding wide seam allowances, pouch openings and handles.
- These can be used for patchwork, quilt, knitting and other various handicrafts.
- Flat back for keeping fabrics down, making it easy to use on sewing machines.

## Wonder Clips <Variety Pack>

All in one convenient package, each unique clips holds your work in place.



3190	
Wonder Clips <Variety Pack> (26 pcs.)	
26 pcs./pack	3 packs/box
Package Size	8 x 4 x 1.5 in

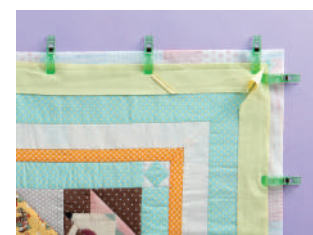
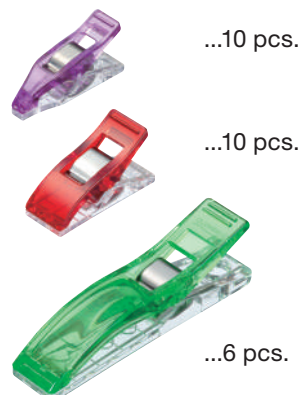



# Slash Cutter

Make beautiful slash quilts quickly!



499	
Slash Cutter	
1 set/pack	3 packs/box
Package Size	8.74 x 3.9 x 0.67 in

Comes with two interchangeable guides; for straight slash cutting and curved slash cutting. Designed with comfort and safety features!



Straight slash cutting

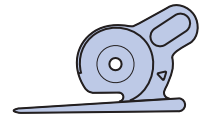

Curved slash cutting

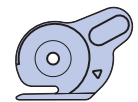

\*This cutter only supports Clover's replacement blades.

## Quilting method with beautiful layers of colour and soft texture

Making slash quilting fun, beautiful and easy.

Slash quilting is a method of quilting. In this method, multiple layers of fabric are arranged on top of a base fabric and are sewn parallel to the true bias direction. Then, seams of all layers but the bottom layer are cut through and washed, and the fabric of the openings is raised.

Slash quilting is known for its beautiful layers of colour and soft texture. Slash quilting can be done easily and quickly with Clover's Slash Cutter.

### Features of Clover Slash Cutter

#### The ratchet mechanism to firmly fix the blade in place

The ratchet mechanism to prevent the blade from rotating when it is being pushed. As the blade doesn't rotate, the fabric won't get caught in between the blade and the guide, allowing for smooth cutting of several layers of fabric.

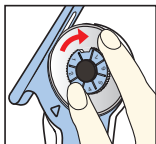

#### 16-step pitch feeding to maintain cutting quality

Turn 1 pitch once the blade becomes dull to improve cutting quality. It is designed so that it is easy to tell when to replace the blade.

#### The cutter comes with a guides for both straight/curved

It works with both types of slash quilts by switching the interchangeable guides. Both for stitching intervals wider than 6mm.



Insert into a channel between two stitching lines and push forward.



Fabric will be cut as you push the cutter forward.

## <Basic technique of slash quilting and how to use a Slash Cutter>

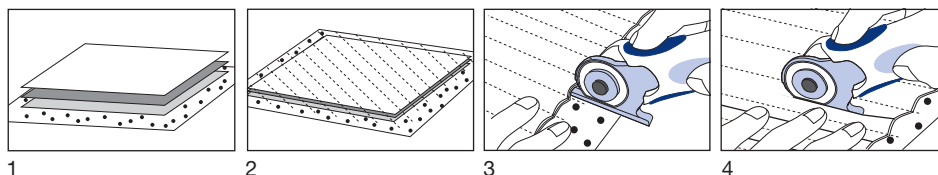

1. Layer pieces of fabric so that the fabric grain is aligned. Select a piece of fabric that has a surface which raises easily as the middle layer, and place a larger piece of fabric as the bottom layer for easy cutting.
2. With a sewing machine, make seams with a fixed width in the true bias direction (in a 45 degree angle to the fabric grain).
3. Insert the Slash Cutter guide in between the seams. (Place the guide on top of the bottom layer.)
4. Hold the fabric down with one hand and push the Slash Cutter forward to cut. (Make a cut with scissors if it is hard to cut at the beginning)
5. Once all the cutting is done, wash with a washing machine and raise fabric. Dry and add the finishing touches to complete.





# Scissors

## Bordeaux Ultimate Scissors/Shears

Innovative technique ensures a fine cut and unsurpassed durability.

These small, portable stainless-steel scissors can smoothly cut thick or multiple layers of fabric. With strong, durable blades and soft-to-grip handle, the scissors ensures a fine cut.

**• Sharpness and durability**  
Sharpness and durability are achieved by precision grinding of high quality stainless steel. This allows us to cut thick, dense or multiple layers of fabric easily and with precision.

**• Easy-to-grip handle**  
The easy-to-grip handle is designed to minimize the fatigue associated with numerous or long cuts. The handle is ambidextrous.

**• Durable blades**  
Scissors with highly durable blades made of high-quality stainless steel treated with a hardening process.

**Genuine leather sheath included**



5 1/8 in.



6 3/4 in.



7 3/4 in.

<b>4940</b>	
<b>Bordeaux Ultimate Scissors 130</b> with NANCYZIEMAN®	
1 pc./pack	3 packs/box
Package Size	7 x 2.30 x 0.25 in

Superior quality for scissors of this size. Turn around easily with small blades.

<b>4941</b>	
<b>Bordeaux Ultimate Scissors 170</b> with NANCYZIEMAN®	
1 pc./pack	3 packs/box
Package Size	7.25 x 2.30 x 0.25 in

Handy size. Fine cuts even when aligning piece cuts and seam allowances.

<b>4942</b>	
<b>Bordeaux Ultimate Scissors 200</b> with NANCYZIEMAN®	
1 pc./pack	3 packs/box
Package Size	10.75 x 4 x 0.75 in

Powerful scissors for all kinds of purposes. There's no need to worry about the types of fabric or their thickness.

# Scissors

## Patchwork Scissors



**493/L**  
Patchwork Scissors  
(Large)

1 pc./pack	3 packs/box
Package Size	11.5 x 4 x 0.5 in

Made from top-grade stainless steel, sharp and durable excellent for cutting multiple layers of fabric.



9.5 in



**493**  
Patchwork Scissors

1 pc./pack	3 packs/box
Package Size	9 x 3.25 x 0.45 in

Perfect for cutting multiple layers of fabric or cutting pieces for quilting. A cover is included for safe and easy handling and storage.



7 in



**493/S**  
Patchwork Scissors  
(Small)

1 pc./pack	3 packs/box
Package Size	7.25 x 3 x 0.45 in

Perfect for cutting appliqué pieces for quilting and sewing.



5.5 in

### 493/L, 493, 493/S

The finely serrated blades will grip the fabric firmly for a precision cut. Perfect for cutting multiple layers of fabric as well as quilt batting.

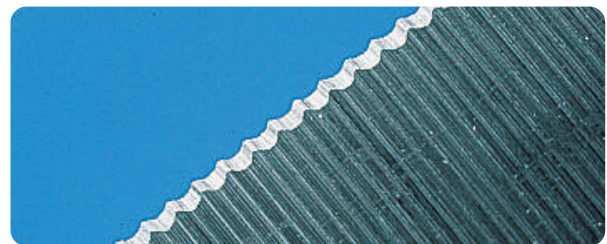

Perfect for fine cutting.



**493/CW**  
Patchwork Scissors  
(Mini)

1 pc./pack	3 packs/box
Package Size	7.25 x 3 x 0.45 in

The pointed tip is perfect for fine cutting and trimming. Used for chenille quilting, appliqué, sewing and crafts. Heavy duty blades make it easy to cut through several layers of fabric.

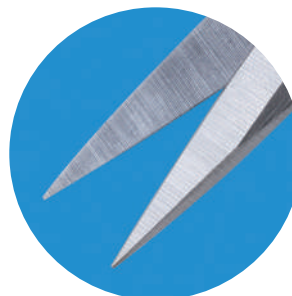

4.5 in



# Rotary Cutters

Perfect cutter for patchwork requiring accuracy

Rotary cutters are the ultimate in simplicity and functionality. Fits into your hand perfectly and allows for accurate and speedy cuts.

## Features of Clover Rotary Cutter

Hold upright



At an angle



- **Cuts beautifully regardless of how you hold it**

Cuts beautifully regardless of how you hold it, whether held upright or at an angle as the cover opens at a tilt, due to the wide cutting range with just the right amount of blade exposed.

- **An easy grip handle that fits into your hand perfectly**

The “Soft Cushion Handle” gently supports your palm and fingers for a comfortable cutting experience. For speedy and accurate cuts with a cutter that fits into your hand perfectly.

**\*Can be used for both left and right handed users**

Can be used by both right and left hand by simply turning the safety cover around.

\*The cutter is initially set to right-hand use.

- **Adjustable rotation speed**

Rotation speed can be adjusted with the tightening screw at the back.

The blade will rotate slower when the screw is tightened allowing for cutting thick or multiple layers of fabric beautifully.

Cover opens at a tilt!

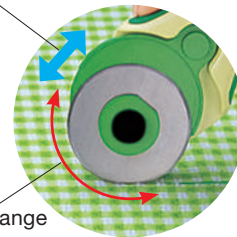

Wide cutting range

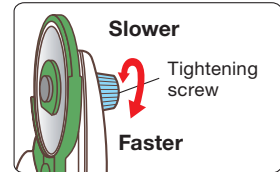

<b>7500</b>	
Rotary Cutter (45 mm)	
0 51221 52250 5	
1 pc./pack	3 packs/box
Package Size	9 x 4.7 x 1 in

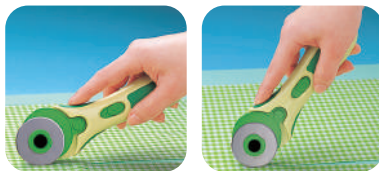

<b>7502</b>	
Rotary Cutter (60 mm)	
0 51221 52252 9	
1 pc./pack	3 packs/box
Package Size	10.5 x 4.7 x 1.3 in

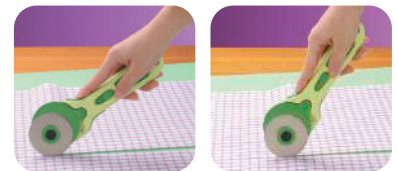

<b>7501</b>	
Rotary Cutter (28 mm)	
0 51221 52251 2	
1 pc./pack	3 packs/box
Package Size	9 x 4 x 1 in

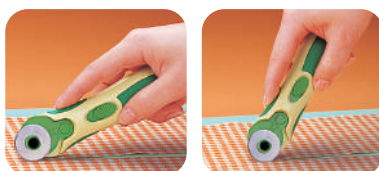

<b>7503</b>	
Rotary Cutter (18 mm)	
0 51221 52253 6	
1 pc./pack	3 packs/box
Package Size	9 x 3 x 0.75 in

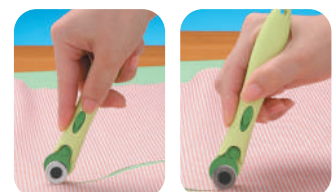



# Rotary Cutter Blades

Clover Rotary Blade Refills make blade replacement safe, quick and easy.

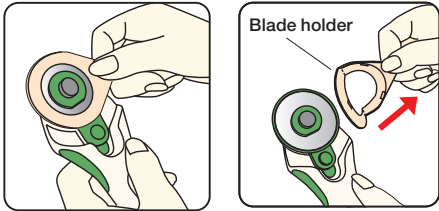

Blades come in a protective cover for safe handling.



45 mm

<b>7508</b>	
Clover Rotary Blade Refill (45 mm/1 pc.)	
1 pc./pack	3 packs/box
Package Size	6.3 x 2.75 x 0.1 in



60 mm

<b>7510</b>	
Clover Rotary Blade Refill (60 mm/1 pc.)	
1 pc./pack	3 packs/box
Package Size	8 x 3 x 0.2 in



28 mm

<b>7514</b>	
Clover Rotary Blade Refill (28 mm/2 pcs.)	
2 pcs./pack	3 packs/box
Package Size	6.3 x 2.75 x 0.1 in



18 mm

<b>7512</b>	
Clover Rotary Blade Refill (18 mm/2 pcs.)	
2 pcs./pack	3 packs/box
Package Size	6 x 2.75 x 0.55 in



45 mm

<b>7509</b>	
Clover Rotary Blade Refill (45 mm/5 pcs.)	
5 pcs./pack	3 packs/box
Package Size	6.3 x 3 x 0.7 in



60 mm

<b>7511</b>	
Clover Rotary Blade Refill (60 mm/5 pcs.)	
5 pcs./pack	3 packs/box
Package Size	8 x 3.75 x 0.7 in



28 mm

<b>7515</b>	
Clover Rotary Blade Refill (28 mm/5 pcs.)	
5 pcs./pack	3 packs/box
Package Size	6 x 2.75 x 0.5 in



18 mm

<b>7513</b>	
Clover Rotary Blade Refill (18 mm/5 pcs.)	
5 pcs./pack	6 packs/box
Package Size	6 x 2.75 x 0.5 in



# Tape Makers

## Cutting Mat

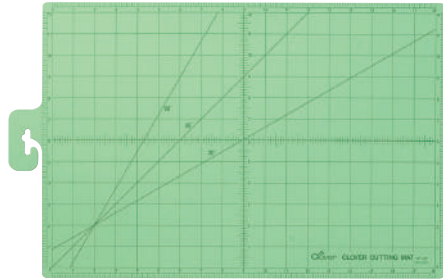

<b>7520</b>	
<b>Cutting Mat (12" x 18") Inch Gauge</b>	
6 pcs./box	
Size	18.25 x 12.5 x .12 in

## Bias Tape Makers

*You can make bias tapes in minutes!*

*You can quickly make bias tapes of the same width using the same fabric for belt loops and the piping finishing of armholes and necklines.*

How to use:

- (1) Cut the fabric according to size.
- (2) Insert the fabric through the tape maker.
- (3) Pin the fabric edge and iron the folded tape as you pull the tape maker.



464/06 1/4 in  
464/12 1/2 in  
464/18 3/4 in  
464/25 1 in  
464/50 2 in

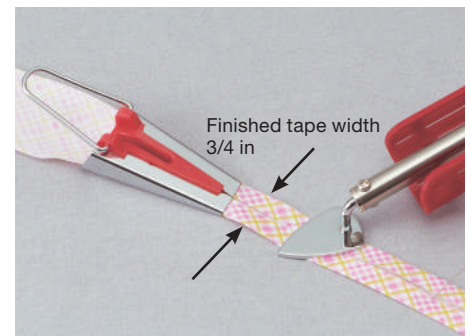

Finished tape width 3/4 in  
Insert the fabric through the bias tape maker and iron.

<b>464/06</b>	
<b>Bias Tape Maker (1/4 in)</b>	
1 pc./pack	3 packs/box
Package Size	6.7 x 3 x 1 in

<b>464/12</b>	
<b>Bias Tape Maker (1/2 in)</b>	
1 pc./pack	3 packs/box
Package Size	6.7 x 3 x 1 in



<b>464/18</b>	
<b>Bias Tape Maker (3/4 in)</b>	
1 pc./pack	3 packs/box
Package Size	6.7 x 3 x 1 in

<b>464/25</b>	
<b>Bias Tape Maker (1 in)</b>	
1 pc./pack	3 packs/box
Package Size	6.7 x 3 x 1 in

<b>464/50</b>	
<b>Bias Tape Maker (2 in)</b>	
1 pc./pack	3 packs/box
Package Size	6.7 x 3 x 1.5 in

# Tape Makers

## Fusible Bias Tape Makers

From Celtic Quilt appliqué to temporary piping tapes, this tape maker will expand the creativity of your work.

### How to use:

- (1) Insert the Fusible Web (Heat Adhesive Tape) in the upper groove.
- (2) Insert bias cut fabric in the lower groove.
- (3) Pull both materials at the same time and iron.
- (4) Remove the adhesive tape and apply.



Finished tape width 3/8 in



**4011**  
Fusible Bias Tape Maker  
(1/4 in)

1 pc./pack	3 packs/box
Package Size	6.3 x 2.75 x 1 in

**4012**  
Fusible Bias Tape Maker  
(3/8 in)

1 pc./pack	3 packs/box
Package Size	6.3 x 2.75 x 1 in

By using a 5mm-wide Fusible Web with this 18mm-wide tape maker, you can make bias tapes for piping which can baste fabric.

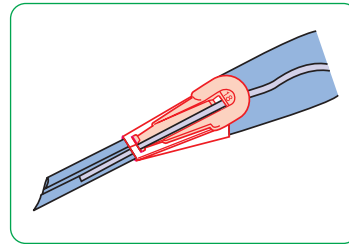

\*You can also make bias tapes without heat adhesive tapes.



**4013**  
Fusible Bias Tape Maker  
(1/2 in)

1 pc./pack	3 packs/box
Package Size	6.3 x 2.75 x 1 in

**4014**  
Fusible Bias Tape Maker  
(3/4 in)

1 pc./pack	3 packs/box
Package Size	6.3 x 2.75 x 1 in

**4015**  
Fusible Bias Tape Maker  
(1 in)

1 pc./pack	3 packs/box
Package Size	6.3 x 2.75 x 1.6 in

## Fusible Web

This tape is convenient for holding Celtic quilt, stained glass quilt and appliqué in place.



4031



4032

**4031**  
Fusible Web  
(1/4 in width/40 ft. roll)

1 pc./pack	3 packs/box
Package Size	5.7 x 4 x 0.5 in

**4032**  
Fusible Web  
(3/4 in width/40 ft. roll)

1 pc./pack	3 packs/box
Package Size	5.7 x 4 x 0.5 in

Release paper



### The Fusible Web

The Fusible Web is a heat adhesive tape in the shape of a spider web that will keep the fabric soft and maintain its touch.

Width of the corresponding Fusible Web  
6/9mm width: 1/4 in  
12/18/25mm width: 3/4 in





# Fabric Tube Maker

Accomplishes two precision folds in one effortless motion.

The Fabric Tube Maker makes creating Jelly Roll® projects a breeze, by inserting fabric and batting strips through parts, which are then effortlessly pulled through the tube maker!



4022 Fabric Tube Maker	
1 set/pack	3 packs/box
Package Size	5.31 x 2.35 x 1.35 in

Create jelly roll rugs, baskets, and more!



Place batting on top of wrong side of fabric.



Insert fabric and batting strips through part A. Place part B in fabric and batting and click into place with part A. Pull fabric and batting through parts A/B.



Insert folded fabric and batting strips into part C to fold again. Place part D on the top of the fabric and batting strips and click into with part C.



Pull the fabric and batting strips through parts C/D. Keep the position of paired units A/B and C/D close to the needle plate and slide along as you sew.

Pair parts A/B and C/D should be combined.

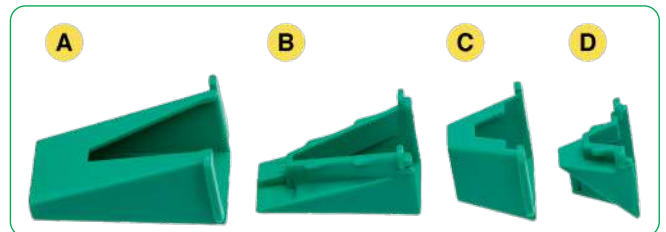

Made of durable and extremely smooth plastic material.

To secure parts of the Fabric Tube Maker make sure section 2 snaps into section 1 with a clip.

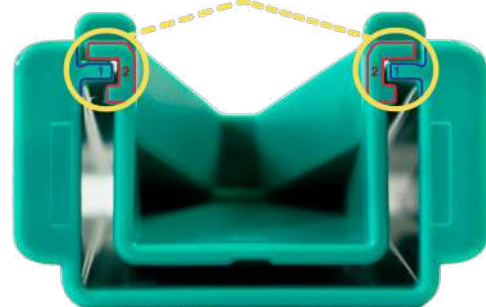

# Mini Iron & Accessories

This small, light iron is very easy to handle and can be used to press small areas.

It features a safety cover and switch on the handle to protect hands and fingers.

**2-step heat control**

**Pilot lamp**  
You can tell the power is on with one look.

**Handy switch**  
It also features a dial for heat control and an on/off switch on the handle.

**Small iron tip**  
Able to press only the necessary areas.

**Thick handle**  
It fits into your hand comfortably for smooth craftwork.

**Safety cover**  
Protects hands and fingers coming into contact with the heated conductor.

**Comes with an iron stand**



Convenient not only for patchwork and quilt but also for sewing and other various handcrafts.



**9100**

**Mini Iron II™ "The Adapter"**

1 set/pack	3 packs/box
Package Size	15 x 5.12 x 1.3 in

**9101**

**Mini Iron II™ "The Adapter Set"**

1 set/pack	3 packs/box
Package Size	16.62 x 9.75 x 1.75 in

**MCI-900**

**Mini Iron**

1 set/pack	3 packs/box
Package Size	14 x 4.12 x 1.5 in

## Interchangeable tips are sold separately

Mini Iron II has special interchangeable tips that can be used for Quilting, Sewing and Crafting. The Mini Iron II has four adaptable tips to be used for doll making, paper crafting and hard to reach corners.

**9103**

**Adapter Iron Tip (Large)**

**9104**

**Adapter Ball Tip**

**9105**

**Adapter Slim Line Tip**

**9106**

**Adapter Hot Knife Tip**

**9107**

**Adapter Hot Knife Tip Blade Refill**

1 pc./pack	3 packs/box
Package Size	7.62 x 2.75 x .3 - 1.2 in



The Large Tip works well on large projects.

The Ball Tip is used for Doll Making and General Crafting.

The Slim Line Tip is perfect for working on seams or fabric folding projects.







# Trace 'n Create Templates with Nancy Zieman

## E-Tablet & Paper Tablet Keepers 2.0

Note from Nancy: Create personalized tablet keepers for paper or electronic tablets such as Kindle Fire, Kindle 2nd Generation, Samsung Galaxy Tablets and more. Now you write, read or e-mail in style.

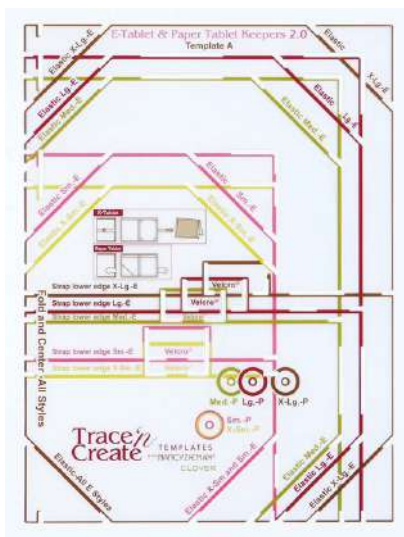

9577

Trace 'n Create Templates  
E-Tablet & Paper Tablet Keepers 2.0



0 51221 79577 0

1 set/pack	3 packs/box
Package Size	13.5 x 11.25 x .25 in



## Bag & Totes Accessories



### Create Piping in minutes!

- Unique feature - Cording is covered with fusible web.
- Create Coordinating pipping in minutes!
- Use with light-medium weight fabrics.



9517

Wrap 'n Fuse Piping (9 mm x 2m)



0 51221 35077 1

1 set/pack	3 packs/box
Package Size	13.12 x 2.75 x 1.25 in

9518

Wrap 'n Fuse Piping (9 mm x 5.5m)



0 51221 35078 8

1 set/pack	3 packs/box
Package Size	16.87 x 3.25 x 2 in



# Embroidery Stitching Tools

Embroider easily by simply thrusting the needle into the fabric!

Enjoy perfectly aligned stitches.



<b>8800</b>	
<b>Embroidery Stitching Tool</b>	
	
1 set/pack	3 packs/box
Package Size	7.3 x 3.75 x 0.8 in

\*Package includes Embroidery Stitching Tool, one 3-ply needle and one needle threader.

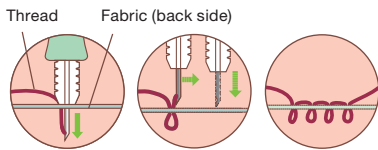



Place the fabric with the design in an embroidery hoop and stitch with a needle as if you were drawing a picture.

**Make a variety of stitches by thrusting the needles into the fabric in the same way.**

**Back stitch**  
 Thrust the needle into the fabric surface. Thrust needle in the direction of stitching.

**Satin stitch**  
 Thrust the needle into the fabric surface. Thrust needle as if filling the surface.

**Loop stitch**  
 Thrust needle from the back of the fabric. Thrust needle while enjoying the three-dimensional look.

**Velvet-like**  
 Thrust needle from the back of the fabric. Cut the end of the loop with scissors.



<b>8801</b>	
<b>Embroidery Stitching Tool Needle Refill (Single Ply Needle)</b>	
	
1 pc./pack	3 packs/box
Package Size	7.3 x 3.75 x 0.8 in

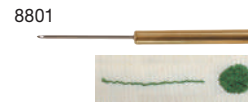

1 pc./pack	3 packs/box
Package Size	7.3 x 3.75 x 0.8 in



<b>8802</b>	
<b>Embroidery Stitching Tool Needle Refill (Needle for Medium-Fine Yarn)</b>	
	
1 pc./pack	3 packs/box
Package Size	7.3 x 3.75 x 0.8 in

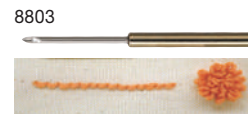

<b>8803</b>	
<b>Embroidery Stitching Tool Needle Refill (6 Ply Needle)</b>	
	
1 pc./pack	3 packs/box
Package Size	7.3 x 3.75 x 0.8 in

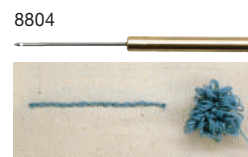

<b>8804</b>	
<b>Embroidery Stitching Tool Needle Refill (3 Ply Needle)</b>	
	
1 pc./pack	3 packs/box
Package Size	7.3 x 3.75 x 0.8 in



<b>8810</b>	
<b>Embroidery Stitching Tool Needle Threader</b>	
	
2 pcs./pack	3 packs/box
Package Size	8 x 1.77 x 0.2 in

Convenient threader for the Embroidery Stitching Tool.

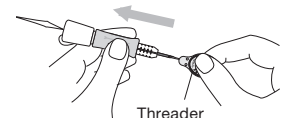



# Embroidery Stitching Tools

Perfect for Embroidery Stitching.

Inner hoop grips the fabric firmly, keeping it tight.



**8812**  
**Clover Embroidery Hoop (7 in)**

1 pc./pack	3 packs/box
Package Size	9 x 7.5 x 0.62 in

**8813**  
**Clover Embroidery Hoop (4 3/4 in)**

1 pc./pack	3 packs/box
Package Size	8.6 x 5 x 0.55 in



The Clover Embroidery Hoop consists of an inner and outer hoop.

Tighten hoop by turning metal dial. Keeps the thread from wrapping around the screw.

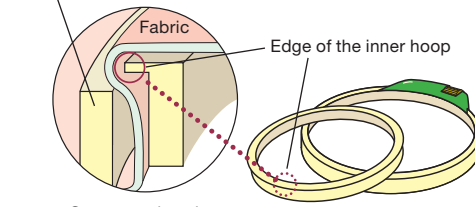

Cross-section view

# "Kantan Couture" Bead Embroidery Tools



This old art of embroidery using a fine hook on a fine cloth stretched in frame is called "Tambour", reborn with Clover's "Kantan Couture" Bead Embroidery Tool.

Basic techniques with this tool can create beautiful motifs using sequins and beads. Embellish/Design and make it your own. Your imagination possibilities are endless.



**9900**  
**"Kantan Couture" Bead Embroidery Tool**

1 set/pack	3 packs/box
Package Size	8.6 x 2.5 x 1 in

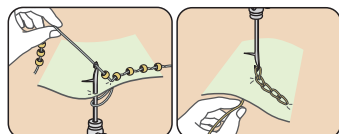

Beads and sequins are easily applied. Chain-stitching is a breeze.



**9901**  
**"Kantan Couture" Bead Embroidery Tool Needle Refill**

1 pc./pack	6 packs/box
Package Size	5.5 x 2.12 x 0.1 in

Replacement needle exclusively for Bead Embroidery Tool. Easy replacement with a screw on the handle.

# Swift Bead

## Quick beading needles.

Quickly string your beads with the Swift Bead.  
Great to use for crochet and knitting with beads.  
Add beaded fringe to your projects, and embellish with beads.

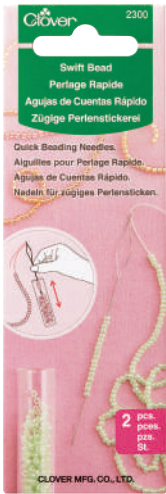

2300	
Swift Bead	
2 pc./pack	3 packs/box
Package Size	6 x 2 x 0.05 in

- Needle length: 75 mm
- Suitable beads: 15/0 - 11/0
- \*Round beads, cylinder beads, etc.

## How to use

\*Loose beads should be put in a long, narrow container.

1. Put a string through the needle.
2. Move the needle up and down.
3. Pull string through the beads.

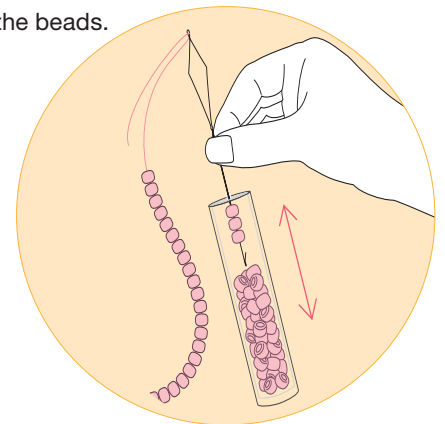

# Stitch Dome

For easy and speedy embroidery and hemstitching!



8830	
Stitch Dome	
1 set	3 packs/box
Package Size	5.5 x 3.5 x 1 in

- Stitch dome x 1
- Rubber x 1

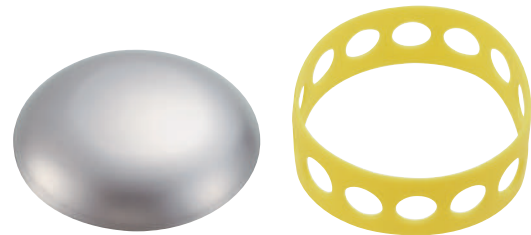

Diameter: approx. 3.3/8 in Height: approx. 1.1/16 in

## How to use



1. Place the Stitch Dome under the fabric.



2. Fix the fabric with the elastic band, work on your embroidery or hemstitching using the surface of the Stitch Dome.

## The secret to its ease of use

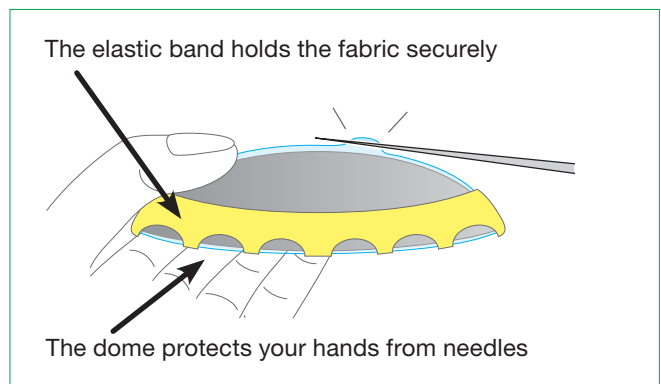

Embroidery



Appliqué



Sewing



\*\*"Wonder Clips" are not included in the set.





# “QUICK” Yo-Yo Makers

Quick and easy Yo-Yo Maker templates!

“QUICK” Yo-Yo Makers allow you to make evenly spaced stitches to create beautiful gathers. Fold the seam allowance, rounding off to make a nicely shaped yo-yo.



Place the fabric between the plates and cut off the seam allowance leaving 3-5mm.

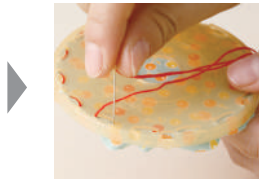

Stitch following the holes in the plates.



Remove the plates and gather the thread.

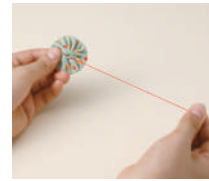

Gather tightly, knot the end and hide it by placing it inside.



Round off to a nice shape and voila!



**8702**  
“QUICK” Yo-Yo Maker  
(Extra Small)

0 51221 55772 9

1 set/pack	3 packs/box
Package Size	8.6 x 4 x 0.4 in



**8700**  
“QUICK” Yo-Yo Maker  
(Small)

0 51221 55770 5

1 set/pack	3 packs/box
Package Size	8.6 x 4 x 0.4 in



**8701**  
“QUICK” Yo-Yo Maker  
(Large)

0 51221 55771 2

1 set/pack	3 packs/box
Package Size	8.6 x 4.7 x 0.4 in



**8703**  
“QUICK” Yo-Yo Maker  
(Extra Large)

0 51221 55773 6

1 set/pack	3 packs/box
Package Size	8.6 x 5.7 x 0.4 in

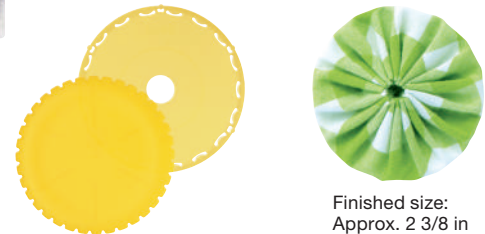

**8708**  
“QUICK” Yo-Yo Maker  
(Jumbo)

0 51221 55778 1

1 set/pack	3 packs/box
Package Size	9 x 7.5 x 0.6 in

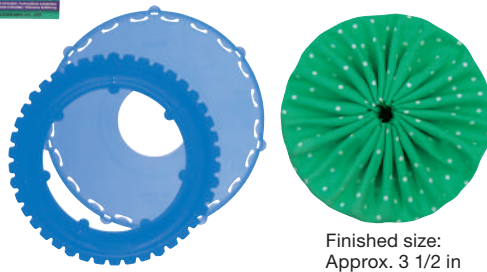

**8705**  
“QUICK” Yo-Yo Maker  
(Heart-Shape/Large)

0 51221 55775 0

1 set/pack	3 packs/box
Package Size	8.75 x 4.12 x 0.6 in



# Kanzashi Flower Makers

Simply set, cut and sew to create beautiful Kanzashi Flowers!

Kanzashi is a traditional Japanese art form of folding and stitching fabric petals for use in beautiful hair adornments.

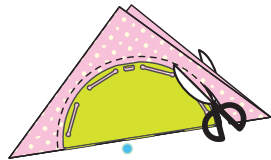

Finished size:  
Approx. 2 in

**8484**  
Kanzashi Flower Maker  
(Gathered Petal/Small Size)



1 pc./pack    3 packs/box  
Package Size    8.6 x 4 x 0.25 in



Finished size:  
Approx. 3 in

**8485**  
Kanzashi Flower Maker  
(Gathered Petal/Large Size)



1 pc./pack    3 packs/box  
Package Size    8.6 x 4.4 x 0.25 in



Finished size:  
Approx. 3 in

**8483**  
Kanzashi Flower Maker  
(Pointed Petal/Large Size)



1 pc./pack    3 packs/box  
Package Size    8.6 x 4.4 x 0.25 in



Finished size:  
Approx. 2 in

**8486**  
Kanzashi Flower Maker  
(Orchid Petal/Small Size)



1 pc./pack    3 packs/box  
Package Size    8.6 x 4 x 0.25 in



Finished size:  
Approx. 3 in

**8487**  
Kanzashi Flower Maker  
(Orchid Petal/Large Size)



1 pc./pack    3 packs/box  
Package Size    8.6 x 4.4 x 0.25 in

# Flower Frill Templates



**8461**  
Flower Frill Templates  
(Large & Extra Large Sizes)



4 sheets/pack    3 packs/box  
Package Size    8.6 x 6.25 x 0.25 in

Approx. Finished sizes & Contents

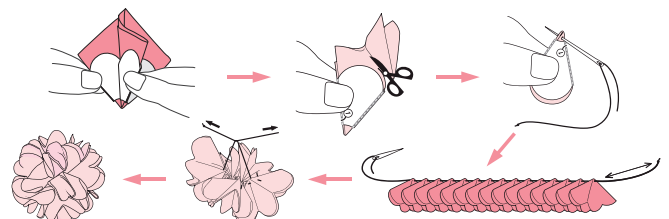
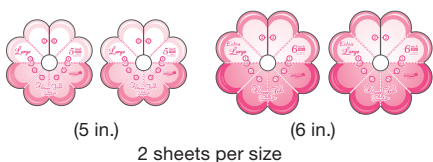





# Wonder Knitter

The sweet old spool knitting has come back in a cute design!

The Wonder Knitter is extremely easy to use and you'll never get tired of knitting!

The rotating disk makes knitting easy and fast. A variety of materials can be used, such as beads and nylon string.



**3101**  
**Wonder Knitter™**

1 set/pack	3 packs/box
Package Size	8.6 x 5 x 2 in



**The secret of easy knitting is the rotating disc**

Turn the disc and the thread will automatically come into place. No need to adjust thread position and tension for easy knitting.



- Contents**
- Main body: 1 pc.
  - Crochet Hook: 1 pc.
  - 3-peg Head: 1 pc.
  - 6-peg Head: 1 pc.



Pick up lower stitch.

Hook over upper yarn onto pin.

Rotate disk and continue.

**Change the disc with just one touch!**

Use 3 pins to knit a thin cord and 6 pins to knit a thick cord. Knit cords of two different sizes by changing the disc. Easy and quick knitting!

# French Knitter

Create dazzling accessories with beads on nylon, yarns, and embroidery threads.



**3100**  
**French Knitter**  
**—Bead Jewelry Maker—**

1 set/pack	3 packs/box
Package Size	8.6 x 5 x 1.5 in

- Contents**
- Main body: 1 pc.
  - Crochet Hook: 1 pc.
  - 4-peg Head: 1 pc.
  - 5-peg Head: 1 pc.
  - 6-peg Head: 1 pc.



3 interchangeable heads included



# Flower Loom

Setting a frame on the loom base and mending a thread with the pin are all you need to do to make a flower motif!



Enjoy making a variety of motifs through many different frames, combinations and ways of binding and mending!

Create beautiful fun-flowers in every season with wool, yarn, ribbon or raffia in different shapes and sizes. The Flower Loom is the perfect embellishing tool for all ages. The flowers can be joined together to make beautiful wearable art, home decor accessories such as pillows, trimmings, and bags.



3146	
Flower Loom	
1 set/pack	3 packs/box
Package Size	8.6 x 5 x 2 in



1. Set the loom on the base.



2. Wind the yarn around the pegs in a criss-cross fashion.



3. Weave the yarn around each petal to make the center.



4.



Connect motifs to make a bag!



Accentuate your needlework with a corsage!

# Bracelet Maker

Make decorative bracelets by knotting and weaving threads.

Create 8 different bracelet styles with a variety of decorative yarns, threads and beads.

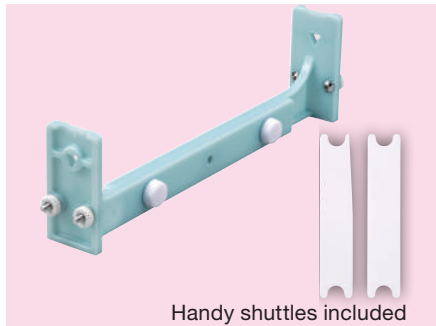

Handy shuttles included

9943	
Bracelet Maker	
1 set/pack	3 packs/box
Package Size	10 x 2.5 x 1.3 in

You can make your favorite bracelet combining the techniques you choose for each of Part-A and B.



Enjoy 8 creative style variations.

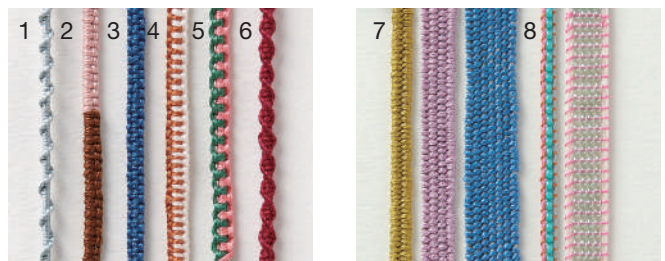

Knotting

Weaving

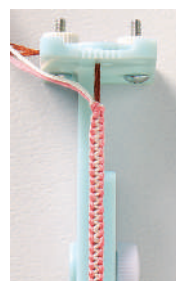
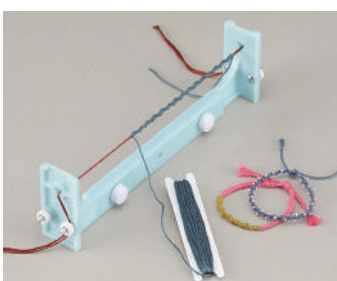



# Pom-Pom Makers

**Beautiful Pom-Poms Made Easy!**

The measuring scale on the arch makes it easy to create multi-colored pom-pom.

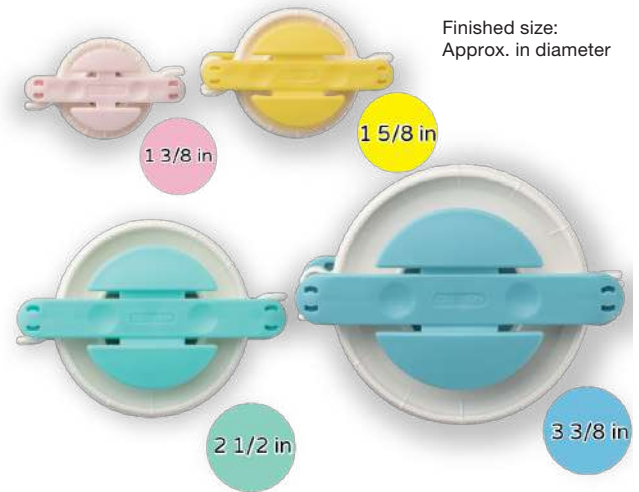
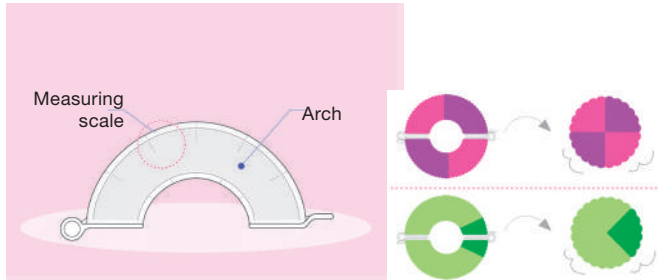

1. Wind the yarn.



2. Cut the yarn.



3. Tie with thread.



4. Open one arch at a time.



5. Remove Pom-Pom Maker.



6. Trim loose ends to shape.



**3129**  
**Pom-Pom Maker Set**



4 pcs./pack	3 packs/box
Package Size	8.6 x 5 x 1.45 in

Includes 4 Pom-Pom Makers in different sizes with new specifications!  
Finished size: Approx. 1-3/8, 1-5/8, 2-1/2, 3-3/8 inches in diameter



**3124**  
**Pom-Pom Maker (Small)**



2 pcs./pack	3 packs/box
Package Size	6.5 x 3 x 1.25 in

Finished size: Approx. 1-3/8, 1-5/8 inches in diameter



**3126**  
**Pom-Pom Maker (Large)**



2 pcs./pack	3 packs/box
Package Size	8.6 x 4 x 1.4 in

Finished size: Approx. 2-1/2, 3-3/8 inches in diameter





# Pom-Pom Makers



**3127**  
Pom-Pom Maker (Extra Small)



2 pcs./pack	3 packs/box
Package Size	6.5 x 2.75 x 1 in

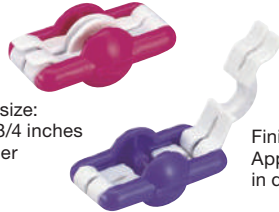

Finished size:  
Approx. 3/4 inches  
in diameter

Finished size:  
Approx. 1 inch  
in diameter



**3128**  
Pom-Pom Maker (Extra Large)



1 pc./pack	3 packs/box
Package Size	8.6 x 5.5 x 2 in



Finished size:  
Approx. 4-1/2 inches in  
diameter

# Tassel Makers



How to use



**Create tassels with your favorite threads!**

Easily make tassels with embroidery thread, woolen yarns and others.

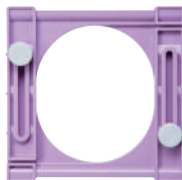

**9940**  
Tassel Maker (Small)



1 pc./pack	3 packs/box
Package Size	8.6 x 5.7 x 0.8 in



**9941**  
Tassel Maker (Large)



1 pc./pack	3 packs/box
Package Size	8.6 x 6.3 x 0.8 in





# Hair Pin Lace Tool

**Easily braid scarves, chokers, stoles, and so on.**  
Change blade width with the pin position.

**As the ends clip on and off:**

You can quickly make long braids without any interruption.

“Hair Pin Lace” is a traditional interwoven braid that can be made using a basic technique known as “single crochet”.  
Make braid widths: 1 - 3 inches.  
You can set every 3/8 inch.

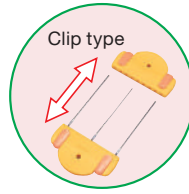



**With 3 pins:**

Set a third pin in the middle for an even more beautiful braid.  
As there are holes in the pin, you can pass other threads through the braid while braiding.  
This lace tool can even be used for a variety of purposes, including connecting braids and make gathers.

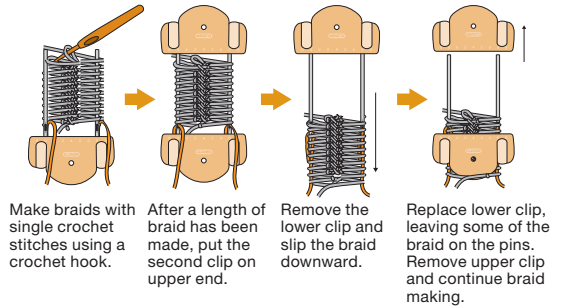

**How to use:**



<b>3104</b>	
<b>Hair Pin Lace Tool</b>	
	
1 set/pack	3 packs/box
Package Size	8.6 x 6 x 0.7 in

# Needle Felting Tools



<b>8901</b>	
<b>Pen Style Needle Felting Tool</b>	
	
1 set/pack	3 packs/box
Package Size	8.6 x 3.75 x 1.4 in

**Fine Weight Needle**  
Size 40/Triangle x 3 pcs.

For small and delicate felt projects using 1, 2 or 3 needles.

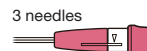
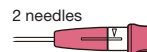
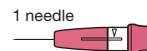
- 3 needles  For a quick finish
- 2 needles  For creating lines and outlines
- 1 needle  For delicate work



<b>8900</b>	
<b>Needle Felting Tool</b>	
	
1 set/pack	3 packs/box
Package Size	8.6 x 3.75 x 1.4 in

**Fine Weight Needle**  
Size 40/Triangle x 5 pcs.

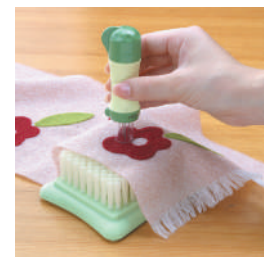

No thread or glue needed!  
Clover's Needle Felting Tool has five barbed needles that catches the wool roving fibers and pushes them into the bottom of the fabric. The wool roving fibers stay permanently without using glue or sewing it. The tool comes with a clear lock cover for safety and storage.



<b>8905</b>	
<b>Needle Felting Tool Refill Needle (Fine Weight Needle)</b>	
	

<b>8906</b>	
<b>Needle Felting Tool Refill Needle (Heavy Weight Needle)</b>	
	

5 pcs./pack	3 packs/box
Package Size	8.6 x 2.3 x 0.4 in

- 8905**  
 **Fine Weight Needle**  
Size 40/Triangle  
(No coating)
- 8906**  
 **Heavy Weight Needle**  
Size 36/Triangle  
(Red)

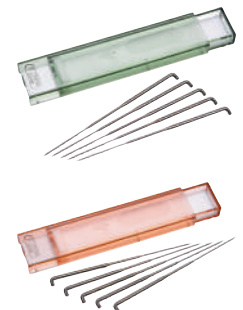

Replacement needle for Needle Felting Tool and Pen Style Needle Felting Tool.

# Needle Felting Tools

The brush-like mat enables smooth punching with little resistance, and allows the fibers of the appliqué to become well meshed with the fabric.



8910  
2-3/4 x 3-1/2 in.

<b>8910</b>	
Needle Felting Mat (Small)	
1 pc./pack	3 packs/box
Package Size	9 x 5.5 x 2 in



8911  
3-1/4 x 5 in.

<b>8911</b>	
Needle Felting Mat (Large)	
1 pc./pack	3 packs/box
Package Size	9.75 x 5.7 x 2 in



<b>8919</b>	
Claw and Mat Cleaner	
1 pc./pack	3 packs/box
Package Size	8.6 x 3.75 x 1.4 in



Holds small motifs in the desired position.



Blends wool roving colors together.



Cleans out fibers to the roots of the Needle Felting Mat.

# Natural Wool Rovings



100% Wool  
Net: approx. 20g

<b>7920-7939</b>	
Natural Wool Roving	
1 pc./pack	3 packs/box
Package Size	7 x 5.5 x 2 in

For Needle Felting, Pom-Pom Makers and other yarn crafts.

	<b>7920</b> Off White			<b>7929</b> Gold	
	<b>7921</b> Lime Green			<b>7931</b> Brown	
	<b>7922</b> Moss Green			<b>7932</b> Black	
	<b>7923</b> Blue			<b>7933</b> Ash	
	<b>7926</b> Pink			<b>7935</b> Caramel	
	<b>7927</b> Red			<b>7939</b> Light Blue	



# Tatting Shuttles



**479**  
**Tatting Shuttle**

2 pcs./pack	3 packs/box
Package Size	6 x 3 x 0.5 in

\* Assorted 2 pcs. from these 5 colors.



**8107**  
**Spare Bobbin Set (White)**

1 set/pack	3 packs/box
Package Size	7.3 x 3.14 x 0.6 in

Spare Bobbin sets are for exclusive use with Bobbin Tatting Shuttles.

**8108**  
**Spare Bobbin Set (Brown)**

1 set/pack	3 packs/box
Package Size	7.3 x 3.14 x 0.6 in

This case can store a set of tatting shuttles and bobbins.



**8109**  
**Storage Case for Bobbin Tatting Shuttle**

1 set/pack	3 packs/box
Package Size	8.25 x 4 x 1.25 in



This case can store tatting shuttles including L size.



**8110**  
**Storage Case for Tatting Shuttle**

1 set/pack	3 packs/box
Package Size	8.25 x 4 x 1.25 in



# Macrame Plant Hanger Gauge



**8630**  
**Macrame Plant Hanger Gauge**

1 pc./pack	3 packs/box
Package Size	6.5 x 4.25 x 1 in

• Projects with unique designs can be created combining different types of macramé knots



- Using this gauge, knots can be spaced evenly resulting in a beautiful finish
- With 1 in. (approximately 2.5 cm) increments, the gauge can be used to measure from 1 to 10 inches (approximately 2.5 to 25 cm)
- Package includes a Wonder Clip to make holding the gauge in place easier.

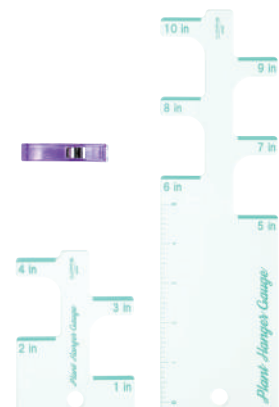



# Mini Weaving Looms

## Simple and Easy!

Easily create woven motifs.  
Many varieties of motifs result from different warp settings and yarn selections!

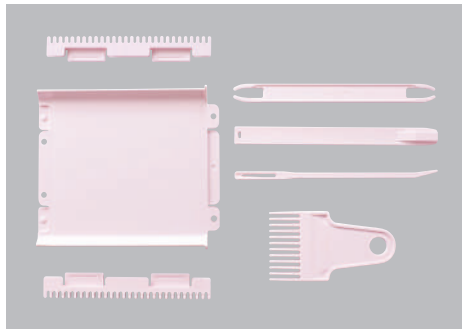
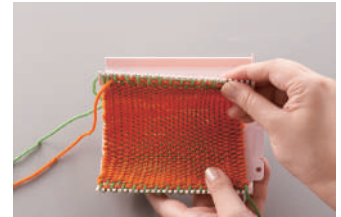
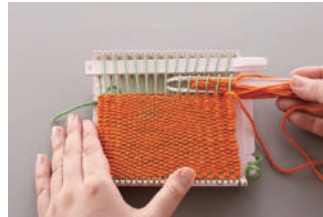
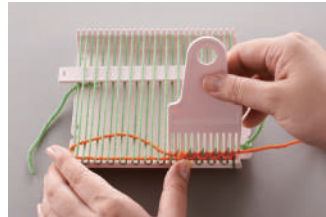
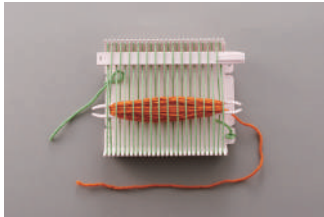

Finished size:  
Approx. 4-3/4 in sq.

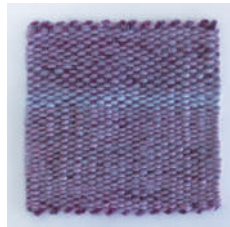

**3176**  
Mini Weaving Loom  
(Single)



1 set/pack	3 packs/box
Package Size	10 x 6.5 x 1.5 in

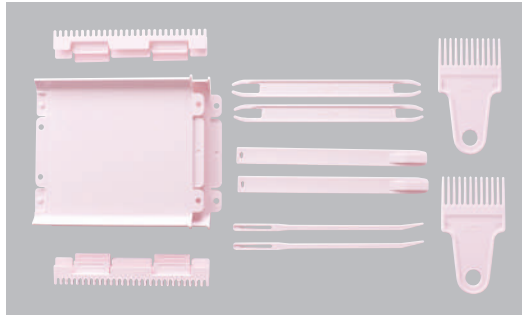

Finished size:  
Approx. 9-3/4 in width, 4-3/4 in length

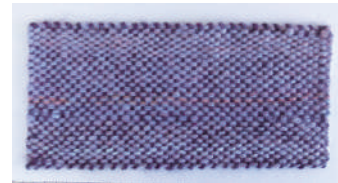

**3177**  
Mini Weaving Loom  
(Double)



1 set/pack	3 packs/box
Package Size	10 x 6.5 x 1.5 in

\*Use the Weaving Loom also as a single.

# Weaving Sticks

## Fun and easy weaving!

Create unique accessories and decorations.



**8440**  
Weaving Sticks  
(Thin)



6 pcs/pack	3 packs/box
Package Size	3 x 7 x 0.25 in

**8441**  
Weaving Sticks  
(Thick)



6 pcs/pack	3 packs/box
Package Size	2.5 x 7 x 0.25 in

# Beading Loom

Enjoy making a variety of beaded art of many different sizes!

## Beading made simple.

Perfectly assembled and gentle on even the most intricate projects. The sophisticated thread holder keeps the warp threads precisely in place and makes beading easy for beginners as well.



1 set/box	
Package Size	12 x 4.7 x 3 in

\* Package does not include beads or thread.

## Weave wonderful accessories with this easy-to-use loom!



Shortest position

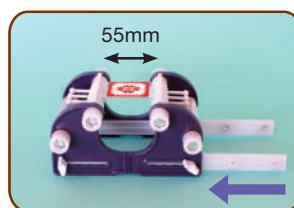

Longest position

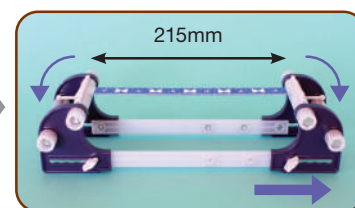

\* Wind woven piece onto winding beam to create even longer works.

Stopper for preventing the warp threads coming undone.

Round beads (11/0) and small round beads can be used with this loom.

You can create different warp threads to match two different bead sizes.

Thread holder for fixing the warp threads in place  
With a comb to align and straighten warp threads!

Easily and accurately adjust the thread length in units of 3/8 in depending on the size of each work.

- Create beautiful beaded artwork by weaving the ends of threads in with the beads for clean ends.
- You can bead up to 1.3m by winding the woven works onto the winding beam.
- Easily wind the beadwork horizontally with the outer dial.

Create everything from accessories to embellishments.





# Beading Loom Kits

Create beautiful beaded jewelry and accessories with TOHO beads.



**9918**  
**Beading Loom Kit (Tulip Brooch)**

1 kit/pack	3 packs/box
Package Size	9 x 5 x 0.6 in



**9921**  
**Beading Loom Kit (Emblem Brooch)**

1 kit/pack	3 packs/box
Package Size	9 x 5 x 0.6 in



**9919**  
**Beading Loom Kit (Butterfly Brooch)**

1 kit/pack	3 packs/box
Package Size	9 x 5 x 0.6 in



**9922**  
**Beading Loom Kit (Pendant Necklace)**

1 kit/pack	3 packs/box
Package Size	9 x 5 x 0.6 in



**9920**  
**Beading Loom Kit (Rose Brooch)**

1 kit/pack	3 packs/box
Package Size	9 x 5 x 0.6 in



**9923**  
**Beading Loom Kit (Bracelet)**

1 kit/pack	3 packs/box
Package Size	9 x 5 x 0.6 in



**9913-9916**  
**Beading Thread #60 Wt 218 yds**

1 pc./pack	3 packs/box
Package Size	6 x 2.5 x 0.25 in

100% polyester beading thread.



	<b>9913</b> Beige	
	<b>9914</b> Brown	
	<b>9915</b> Green	
	<b>9916</b> Light Grey	





# Rosette Makers

It is so easy to create beautiful Rosettes!  
The parts set included will enable you to create a Rosette.

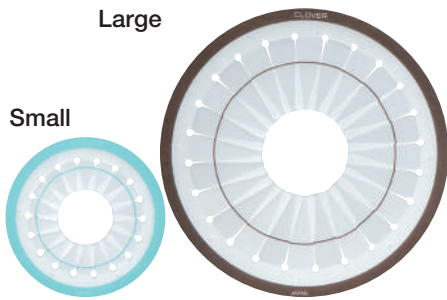

		Small maker		Large maker	
Finished size (approx.)					
		1 3/4 in.	2 in.	3 in.	3 1/2 in.
Ribbon	Width	1/2 in.	3/4 in. / 1 in.	1 in.	1 1/2 in.
	Length	23 in.	23 in.	35 in.	43 in.



**Contents**

**Parts set**

Plate

Center part

Brooch base (felt)

Pin back

Stickers

**8430**  
**Rosette Maker(Small)**

1 set/pack	3 packs/box
Package Size	7 x 5 x 1 in



**Contents**

**Parts set**

Plate

Center part

Brooch base (felt)

Pin back

Stickers

**8431**  
**Rosette Maker(Large)**

1 set/pack	3 packs/box
Package Size	8.6 x 5.7 x 0.4 in

## Parts set for the Rosette Maker(sold separately).



**Contents**

Center part

Brooch base (felt)

Pin back

Stickers



**8432**  
**Rosette Parts Set(Small)**

1 set/pack	3 packs/box
Package Size	7 x 3 x 0.35 in



**Contents**

Center part

Brooch base (felt)

Pin back

Stickers



**8433**  
**Rosette Parts Set(Large)**

1 set/pack	3 packs/box
Package Size	7.5 x 3 x 0.4 in

# Clover Sewing Circle - Clover Knitting Circle

~Where Creativity Never Ends~



**CC-1**  
Clover Sewing & Quilting Circle

1 set/pack	1 packs/box
Rack Size	5.5 ft x 18" x 16"

Clover's Sewing Circle is a collection of essential sewing tools providing for infinite creative potential. It represents an assembly of the very finest sewing notions manufactured by Clover to fit the needs of virtually any sewing technique for home décor, fashion, quilting, or crafting applications. Featured are tools to measure, mark, cut, pin, and sew. Included are needle threaders, bias tape makers, awls, seam rippers, tracing wheels, fusible products and pressing accessories. Every purposeful tool is arranged systematically on a five panel spinner rack. The ultimate product mix assortment for the complete purveyor of fine sewing notions



**CC-2**  
Clover Knitting & Crochet

1 set/pack	3 packs/box
Rack Size	5.5 ft x 18" x 16"

Clover's Knitting Circle is a collection of essential knitting and crochet tools providing for infinite creative potential. It represents an assembly of the very finest knitting and crochet accessories that meet the needs of virtually every creative technique, both current and emerging. Featured prominently is the Takumi line of premium bamboo knitting needles with new precision points, connectors and cables, Takumi Tunisian Crochet Hook sets, Amour premium crochet hooks and all of the most important knitting and crochet accessories. Every purposeful tool and accessory is arranged systematically on a five panel spinner rack. The ultimate product mix assortment for the complete purveyor of fine knitting and crochet offerings.



**4057**  
Desk Needle Threader Assorted (Contains 2 of each color)



1 set/pack	3 packs/box
Package Size	5 3/4" x 4 3/8" x 2"

6 pieces in a display box. Automatic needle threader. This tool is a must for every sewer and quilter. Easy to use and it threads your needles with a simple push of a button. The threader has a built in cutter. The display box assortment comes with 2 Purple, 2 Green and 2 Pink threaders.



**9010**  
Black Gold Hand Sewing Needles POP Display/Wall Hanging

72 pc./pack	1 Assortment
-------------	--------------

Includes 3 of each:  
Quilting size 9, 10, 12 and Assorted  
Quilting between Size 9, 10, 12 and Assorted  
Appliqué/Sharps Size 9, 10, 12 and Assorted  
Total 72 Needles.



**Steve Butler**

Steve has taught numerous classes at all major sewing machine conventions, regional trade shows, International Quilt Market, and various machine embroidery venues.

To Sign up, visit: [Clovertoolschool.com](http://Clovertoolschool.com)

Clover has always prided itself in producing high quality sewing notions that are uniquely useful to our customers. We don't do gadgets. Unfortunately the market place is so full of choices that it is sometimes difficult to separate the wheat from the chaff. To that end we're proud to announce the formation of Clover Tool School. On a bi-monthly basis, or as suitable, Clover will publish an edition of Tool School that focuses on just one product.

~Stay Social With Us~



[www.clover-mfg.com](http://www.clover-mfg.com)

[info@clover-mfg.com](mailto:info@clover-mfg.com)

**CLOVER MFG. CO., LTD.**

3-15-5 Nakamichi, Higashinari-ku, Osaka, Japan

897291

JAN 2022  
170KMT